

15-074

Commercial In Confidence

**The National Survey Of Lotteries, Gaming & Betting Activities
Survey Questionnaire – Follow-up Survey 2015
NRB Version 3
2015**

Questionnaire prepared by National Research Bureau (NRB)

for Auckland University of Technology (AUT) and Ministry of Health (MoH)



CONTENTS

	Page No.
INTERVIEWER ADMINISTRATION SECTION.....	1
1. LEISURE ACTIVITIES AND GAMBLING PARTICIPATION.....	2
LEISURE ACTIVITIES.....	2
PLAYED CARDS FOR MONEY (NOT IN A CASINO).....	5
POKER.....	7
MADE BETS WITH FRIENDS, WORKMATES, ON SUCH THINGS AS THE SUPER 15 RUGBY, NRL, MELBOURNE CUP.....	12
PLAYED A TEXT GAME OR COMPETITION.....	14
BOUGHT A TICKET IN AN OVERSEAS RAFFLE OR LOTTERY (INCLUDES TICKETS BOUGHT IN AN OVERSEAS SHOP, BY TELEPHONE, THROUGH THE POST, OR ONLINE).....	16
BOUGHT A TICKET IN A NZ RAFFLE OR LOTTERY (DOES NOT INCLUDE LOTTERIES COMMISSION GAMES: LOTTO; STRIKE; POWERBALL; BIG WEDNESDAY; KENO; BULLSEYE; OR INSTANT KIWI).....	17
BOUGHT A LOTTERIES COMMISSION LOTTO TICKET (THIS INCLUDES STRIKE; POWERBALL; BIG WEDNESDAY).....	19
BOUGHT A LOTTERIES COMMISSION KENO TICKET.....	22
BOUGHT A LOTTERIES COMMISSION BULLSEYE TICKET.....	25
BOUGHT INSTANT KIWI TICKETS (INCLUDE OTHER SCRATCH TICKETS).....	26
PLAYED HOUSIE OR BINGO IN THE LAST 12 MONTHS.....	28
BET MONEY ON A HORSE OR DOG RACE IN THE LAST 12 MONTHS.....	30
TAB BETS.....	32
HORSE OR DOG RACES THROUGH AN OVERSEAS BETTING ORGANISATION OR OVERSEAS TAB.....	36
BET MONEY ON SPORTING EVENTS.....	38
PLAYED A GAMING MACHINE OR POKIE, TABLE GAMES OR ANY OTHER GAMES AT AN OVERSEAS CASINO (IN PERSON, NOT ONLINE) FOR MONEY.....	44
NEW ZEALAND CASINOS GENERAL.....	45
PLAYED TABLE GAMES IN A CASINO.....	46
PLAYED GAMING MACHINES AT A NEW ZEALAND CASINO (NOT IN A PUB OR CLUB).....	48
PLAYED GAMING MACHINES IN A PUB (NOT IN A CASINO OR CLUB).....	50
PLAYED GAMING MACHINES IN A CLUB (NOT IN A CASINO OR PUB).....	52
MADE SHORT-TERM SPECULATIVE INVESTMENTS LIKE DAY TRADING IN STOCKS AND SHARES.....	55
OTHER ONLINE GAMBLING.....	57
PLAYING GAMBLING TYPE GAMES NOT FOR MONEY OR PRIZES.....	61
GAMBLING PARTICIPATION.....	62

2.	PAST GAMBLING AND RECENT GAMBLING BEHAVIOUR CHANGE.....	66
3.	PROBLEM GAMBLING	69
	PGSI	69
	HELP SEEKING [NEW SECTION].....	72
	TRIED TO GET HELP: IN THE PAST 12 MONTHS.....	72
	GAMBLING IN HOUSEHOLDS.....	76
4.	LIFE EVENTS AND ONGOING HASSLES.....	78
5.	GAMBLING IN NEW ZEALAND.....	82
	NEW ZEALAND GAMBLING INDUSTRY (ALL RESPONDENTS).....	83
6.	MENTAL HEALTH.....	85
	KESSLER	85
	QUALITY OF LIFE (WHOQOL-8)	88
7.	ALCOHOL USE/MISUSE	90
	ALCOHOL USE (AUDIT-C).....	91
8.	SUBSTANCE USE/MISUSE	92
	TOBACCO	92
	OTHER DRUGS	94
9.	HEALTH CONDITIONS.....	95
10.	CONNECTEDNESS.....	96
	NEW ZEALAND DEPRIVATION INDEX (NZDI)	97
11.	DEMOGRAPHICS.....	99
	CULTURAL IDENTITY QUESTIONS.....	101
12.	CLOSING INFO.....	110
	RECONTACT	110

2015 NGS QUESTIONNAIRE

INTERVIEWER ADMINISTRATION SECTION

① INTERVIEWER QUERY

Enter your PSU Number (four digits):

--	--	--	--

Enter the Sampled Home Number (two digits):

--	--

Enter your Interviewer Number (three digits):

--	--	--

1. Answer to Q 11.02 – 11.04 in NGS Main to be carried through.
2. Answers to 11.14 and 11.15 in NGS Main to be carried through.

1. LEISURE ACTIVITIES AND GAMBLING PARTICIPATION

Thank you for taking part in the follow-up survey. Many of the questions are a repeat of those asked in 2012, 2013 **and** 2014, but we do need to ask them again to see what changes, if any, occur over time.

LEISURE ACTIVITIES

The first few questions are about your leisure activities.

95 is a unique code

[Showcard 1A]

1.01 Firstly, Card 1A lists various leisure activities. Please tell me, which of them, in a typical month, you USUALLY do? [Code all that apply]

Ⓢ PROBE: 'What else?'

- 1 Spend time with friends/family
- 2 Read for pleasure
- 3 Listen to music
- 4 Watch TV
- 5 Eat out at restaurants
- 6 Go to pubs/bars/clubs
- 7 Do DIY or gardening
- 8 Go shopping (to the high street or shopping mall)
- 9 Do sports/exercise
- 10 Betting or gambling
- 11 Do arts or crafts
- 12 Play a musical instrument
- 13 Go to the cinema, theatre or music concerts
- 14 Visit museums or galleries
- 15 Attend religious service/place of worship
- 16 Do meditation/yoga/spiritual activities
- 17 Play computer games
- 18 Shop online
- 19 Online chat rooms/social networking sites
- 20 Browsing the internet
- 21 Voluntary or unpaid community work
- 77 Other **[Specify]:** _____
- 95 No leisure activities

NOT ON SHOWCARD:

- .K Don't know
- .R Refused

[Showcard 1B]

1.02 Card 1B lists various activities. For each one listed, please tell me whether or not you have done that activity in the last 12 months. [Circle one answer per line]

		Yes – done in last 12 months	No – not done in last 12 months	Don't know	Refused
a	Played cards for money (not in a casino). This includes in a commercial venue in New Zealand (eg, a pub), with friends or family in a private residence, by telephone, online or by interactive TV	1	5	.K	.R
b	Made bets with friends, workmates, on such things as the NRL, Super 15 Rugby, Melbourne Cup, etc for money or prizes	1	5	.K	.R
c	Played text (mobile phone) games or competitions for money or prizes	1	5	.K	.R
d	Bought a ticket in an overseas raffle or lottery (includes tickets bought in an overseas shop, by telephone, through the post or online)	1	5	.K	.R
e	Bought a ticket in a New Zealand raffle or lottery (this includes school, work, church raffles, etc) (<u>Does not</u> include Lotteries Commission games: Lotto; Strike; Powerball; Big Wednesday; Keno; Bullseye; or Instant Kiwi)	1	5	.K	.R

1.02b/c ① prizes must have an actual monetary value.

[Showcard 1C]

1.03 Now for each activity listed on Card 1C, please tell me whether or not you have done that activity in the last 12 months. [Circle one answer per line]

		Yes	No	Don't know	Refused
a	Bought a Lotteries Commission Lotto ticket (this includes Strike, Powerball and Big Wednesday)	1	5	.K	.R
b	Bought a Lotteries Commission Keno ticket	1	5	.K	.R
c	Bought a Lotteries Commission Bullseye ticket	1	5	.K	.R
d	Bought an Instant Kiwi or other Scratch ticket	1	5	.K	.R
e	Played housie (bingo) for money	1	5	.K	.R
f	Bet money on a horse or dog race (<u>includes</u> any bets made in New Zealand, overseas, or with an overseas betting organisation, whether at the track, a TAB outlet, a TAB in a pub or club, by telephone, online, or by interactive TV. <u>DO NOT</u> include informal bets with friends/workmates on such things as NRL, Super 15 Rugby, Melbourne Cup, etc.)	1	5	.K	.R
g	Bet money on a sporting event, other than horse or dog races (<u>includes</u> any bets made in New Zealand, overseas or with an overseas betting organisation, whether at a TAB outlet, a TAB in a pub or club, by telephone, online or by interactive TV. <u>DO NOT</u> include informal bets with friends/workmates on such things as NRL, Super 15 Rugby, Melbourne Cup, etc.)	1	5	.K	.R
h	Played a gaming machine or pokies, table game or any other game at an overseas casino (in person, not online)	1	5	.K	.R
i	Played a gaming machine or pokies, table game or any other game at one of the six casinos (in NZ)	1	5	.K	.R
j	Played a gaming machine or pokies in a pub (not in a casino or club)	1	5	.K	.R
k	Played a gaming machine or pokies in a club (not in a casino or pub)	1	5	.K	.R
l	Made short-term speculative investments like day trading in stocks and shares	1	5	.K	.R

If **①** not circled in any of 1.02 and 1.03, go to 1.150.
Otherwise go to instruction prior to 1.04.

PLAYED CARDS FOR MONEY (NOT IN A CASINO)

If 1 recorded in 1.02a, go to 1.04.
Otherwise, go to instruction prior to 1.23.

[Showcard 1D]

1.04 You said that you played cards for money (not in a casino) in the last 12 months. [I'll talk about the others in a moment. Programmer: Only insert if first time question asked for activities asked in 1.02. If only one Yes ① recorded in 1.02 do not insert.] About how often do you play cards for money, other than in a casino? This includes in a commercial venue (eg, a pub), with friends or family in a private residence, by telephone, online (eg, via the internet through a PC, laptop, iPad, iPhone or other handheld device), or interactive TV. [Code one only]

- 1 Four times a week or more
- 2 Two or three times a week
- 3 Once a week
- 4 Once every two weeks
- 5 Once every three weeks
- 6 Once a month
- 7 Once every two months
- 8 Once every three months
- 9 Once every six months
- 10 Once a year
- 11 Less frequently than once a year

NOT ON SHOWCARD:

- .K Don't know
- .R Refused

1.05 When you play cards for money, not in a casino, how much do you usually spend in a typical month?

① RECORD TO THE NEAREST DOLLAR, EG, \$60 = 60

① DO NOT RECORD CENTS, EG, \$2.50 = 3

① IF RESPONDENTS SAYS BETWEEN TWO AMOUNTS, IE, \$40 TO \$50 RECORD THE AVERAGE 45

① ENTER NUMBERS ONLY; THAT IS, NO COMMAS, SYMBOLS OR LETTERS,
EG, FOR \$10,000, ENTER 10000

\$ _____

- .K Don't know
- .R Refused

[Showcard 1E]

1.06 Which of the reasons on this card best describes why you play cards for money (not in a casino)? You can choose as many as you like. [Code or record all mentioned]

- 1 To win prizes/money
- 2 For excitement/or a challenge
- 3 To support worthy causes
- 4 Out of curiosity
- 5 To oblige or please other people
- 6 As a gift for another person
- 7 As an interest/or a hobby
- 8 To be with people/get out of the house
- 9 As entertainment
- 77 Other reasons [Specify]: _____

NOT ON SHOWCARD:

- .K Don't know
- .R Refused

1.07 Thinking about playing cards for money, not in a casino, in the last twelve months would you say you have ...? [Read out all and code one only]

- 1 Won money overall
- 2 Broken even
- 3 Lost money overall

DO NOT READ OUT:

- .K Don't know
- .R Refused

1.08 Do you use any system or special skills to improve your chances of winning at playing cards, not in a casino? [Code one only]

- 1 Yes
- 5 No
- 98 Don't know/Don't know of any such system
- .R Refused

**If 1 recorded in 1.08, go to 1.09.
Otherwise go to 1.10.**

1.09 Could you please describe that to me? [Record verbatim]

.R Refused

POKER

1.10 Thinking about the card games you played for money or prizes in the last 12 months, do they include poker? This includes playing poker in a commercial venue (eg, a pub), with friends or family in a private residence, by telephone, online (eg, via the internet through a PC, laptop, iPad, iPhone or other handheld device), or interactive TV. [Code one only]

- 1 Yes
 - 5 No
 - .K Don't know
 - .R Refused
- GO TO INSTRUCTION PRIOR TO 1.23

[Showcard 1F]

1.11 You said that you had played poker for money or prizes, not in a casino in the last 12 months. About how often do you play poker for money or prizes in a commercial venue in New Zealand, eg, a poker night at a pub? Do not include poker with friends or family in a private residence or online. [Code one only]

- 1 Four times a week or more
 - 2 Two or three times a week
 - 3 Once a week
 - 4 Once every two weeks
 - 5 Once every three weeks
 - 6 Once a month
 - 7 Once every two months
 - 8 Once every three months
 - 9 Once every six months
 - 10 Once a year
 - 11 Less frequently than once a year
 - 95 Never
- GO TO 1.12
- GO TO 1.15

NOT ON SHOWCARD:

- .K Don't know → GO TO 1.12
- .R Refused → GO TO 1.15

1.12 When you play poker for money or prizes in a commercial venue in New Zealand, about how much do you bet in a typical month?

- ① RECORD TO THE NEAREST DOLLAR, EG, \$60 = 60
 - ① DO NOT RECORD CENTS, EG, \$2.50 = 3
 - ① IF RESPONDENTS SAYS BETWEEN TWO AMOUNTS, IE, \$40 TO \$50 RECORD THE AVERAGE 45
 - ① ENTER NUMBERS ONLY; THAT IS, NO COMMAS, SYMBOLS OR LETTERS,
EG, FOR \$10,000, ENTER 10000
- \$ _____
- .K Don't know
 - .R Refused

[Showcard 1E]

1.13 Which of the reasons on this card best describes why you play poker for money or prizes in a commercial venue in New Zealand? You can choose as many as you like. [Code or record all mentioned]

- 1 To win prizes/money
- 2 For excitement/or a challenge
- 3 To support worthy causes
- 4 Out of curiosity
- 5 To oblige or please other people
- 6 As a gift for another person
- 7 As an interest/or a hobby
- 8 To be with people/get out of the house
- 9 As entertainment
- 77 Other reasons [**Specify**]: _____

NOT ON SHOWCARD:

- .K Don't know
- .R Refused

1.14 Thinking about playing poker for money or prizes in a commercial venue in New Zealand, in the last twelve months would you say you have...? [Read out all and code one only]

- 1 Won money overall
- 2 Broken even
- 3 Lost money overall

DO NOT READ OUT:

- .K Don't know
- .R Refused

[Showcard 1F]

1.15 About how often do you play poker for money or prizes with friends or family in a private residence? Do not include poker in a commercial venue or online. [Code one only]

- 1 Four times a week or more → GO TO 1.16
- 2 Two or three times a week
- 3 Once a week
- 4 Once every two weeks
- 5 Once every three weeks
- 6 Once a month
- 7 Once every two months
- 8 Once every three months
- 9 Once every six months
- 10 Once a year
- 11 Less frequently than once a year
- 95 Never → GO TO 1.19

NOT ON SHOWCARD:

- .K Don't know → GO TO 1.16
- .R Refused → GO TO 1.19

1.16 When you play poker for money or prizes with friends or family in a private residence, about how much do you bet in a typical month?

- ① RECORD TO THE NEAREST DOLLAR, EG, \$60 = 60
 - ① DO NOT RECORD CENTS, EG, \$2.50 = 3
 - ① IF RESPONDENTS SAYS BETWEEN TWO AMOUNTS, IE, \$40 TO \$50 RECORD THE AVERAGE 45
 - ① ENTER NUMBERS ONLY; THAT IS, NO COMMAS, SYMBOLS OR LETTERS, EG, FOR \$10,000, ENTER 10000
- \$ _____
- .K Don't know
 - .R Refused

[Showcard 1E]

1.17 Which of the reasons on this card best describes why you play poker for money or prizes with friends or family in a private residence? You can choose as many as you like. [Code or record all mentioned]

- 1 To win prizes/money
- 2 For excitement/or a challenge
- 3 To support worthy causes
- 4 Out of curiosity
- 5 To oblige or please other people
- 6 As a gift for another person
- 7 As an interest/or a hobby
- 8 To be with people/get out of the house
- 9 As entertainment
- 77 Other reasons [Specify]: _____

NOT ON SHOWCARD:
 .K Don't know
 .R Refused

1.18 Thinking about playing poker for money or prizes with friends or family in a private residence, in the last twelve months would you say you have...? [Read out all and code one only]

- 1 Won money overall
- 2 Broken even
- 3 Lost money overall

DO NOT READ OUT:
 .K Don't know
 .R Refused

[Showcard 1F]

1.19 About how often do you play poker for money or prizes online (eg, via the internet through a PC, laptop, iPad, iPhone or any other handheld device), or interactive TV? Do not include poker in a commercial venue or with friends or family in a private residence. [Code one only]

Ⓜ NOTE PLAYING FOR POINTS IS NOT INCLUDED

- 1 Four times a week or more → GO TO 1.20
- 2 Two or three times a week
- 3 Once a week
- 4 Once every two weeks
- 5 Once every three weeks
- 6 Once a month
- 7 Once every two months
- 8 Once every three months
- 9 Once every six months
- 10 Once a year
- 11 Less frequently than once a year
- 95 Never → GO TO 1.23

NOT ON SHOWCARD:

.K Don't know → GO TO 1.20

.R Refused → GO TO 1.23

Programmer: If 1.10 = 1 then 1.11, 1.15 and 1.19 can't all = 95.

1.20 When you play poker for money or prizes online, about how much do you bet in a typical month?

① RECORD TO THE NEAREST DOLLAR, EG, \$60 = 60

① DO NOT RECORD CENTS, EG, \$2.50 = 3

① IF RESPONDENTS SAYS BETWEEN TWO AMOUNTS, IE, \$40 TO \$50 RECORD THE AVERAGE 45

① ENTER NUMBERS ONLY; THAT IS, NO COMMAS, SYMBOLS OR LETTERS,
EG, FOR \$10,000, ENTER 10000

\$ _____

.K Don't know

.R Refused

[Showcard 1E]

1.21 Which of the reasons on this card best describes why you play poker for money or prizes online? You can choose as many as you like. [Code or record all mentioned]

- 1 To win prizes/money
- 2 For excitement/or a challenge
- 3 To support worthy causes
- 4 Out of curiosity
- 5 To oblige or please other people
- 6 As a gift for another person
- 7 As an interest/or a hobby
- 8 To be with people/get out of the house
- 9 As entertainment
- 77 Other reasons [**Specify**]: _____

NOT ON SHOWCARD:

.K Don't know

.R Refused

1.22 Thinking about playing poker for money or prizes online, in the last twelve months would you say you have...? [Read out all and code one only]

- 1 Won money overall
- 2 Broken even
- 3 Lost money overall

DO NOT READ OUT:

.K Don't know

.R Refused

MADE BETS WITH FRIENDS, WORKMATES, ON SUCH THINGS AS THE SUPER 15 RUGBY, NRL, MELBOURNE CUP

If 1 recorded in 1.02b, go to 1.23.
Otherwise, go to instruction prior to 1.29.

[Showcard 1D]

1.23 You said that you made bets with friends, workmates, on such things as the Super 15 Rugby for money or prizes in the last 12 months. [I'll talk about the others in a moment.] About how often do you make bets with friends, workmates, on such things as the Super 15 Rugby? [Code one only]

- 1 Four times a week or more
- 2 Two or three times a week
- 3 Once a week or more
- 4 Once every two weeks
- 5 Once every three weeks
- 6 Once a month
- 7 Once every two months
- 8 Once every three months
- 9 Once every six months
- 10 Once a year
- 11 Less frequently than once a year

NOT ON SHOWCARD: .K Don't know .R Refused

1.24 When you make bets with friends, workmates, on such things as the Super 15 Rugby, how much do you usually spend in a typical month?

- ① RECORD TO THE NEAREST DOLLAR, EG, \$60 = 60
 - ① DO NOT RECORD CENTS, EG, \$2.50 = 3
 - ① IF RESPONDENTS SAYS BETWEEN TWO AMOUNTS, IE, \$40 TO \$50 RECORD THE AVERAGE 45
 - ① ENTER NUMBERS ONLY; THAT IS, NO COMMAS, SYMBOLS OR LETTERS, EG, FOR \$10,000, ENTER 10000
- \$ _____
- .K Don't know
 - .R Refused

[Showcard 1E]

1.25 Which of the reasons on this card best describes why you make bets with friends, workmates, on such things as the Super 15 Rugby? You can choose as many as you like. [Code or record all mentioned]

- 1 To win prizes/money
- 2 For excitement/or a challenge
- 3 To support worthy causes
- 4 Out of curiosity
- 5 To oblige or please other people
- 6 As a gift for another person
- 7 As an interest/or a hobby
- 8 To be with people/get out of the house
- 9 As entertainment
- 77 Other reasons [**Specify**]: _____

NOT ON SHOWCARD: .K Don't know .R Refused

1.26 Thinking about making bets with friends, workmates, on such things as the Super 15 Rugby, in the last twelve months would you say you have ...?
[Read out all and code one only]

- 1 Won money overall
- 2 Broken even
- 3 Lost money overall

DO NOT READ OUT:

- .K Don't know
- .R Refused

1.27 Do you use any system or special skills to improve your chances of winning when making bets with friends, workmates, on things such as the Super 15 Rugby?[Code one only]

- 1 Yes
- 5 No
- 98 Don't know/Don't know of any such system
- .R Refused

**If 1 recorded in 1.27, go to 1.28.
Otherwise go to instruction prior to 1.29.**

1.28 Could you please describe that to me? [Record verbatim]

.R Refused

PLAYED A TEXT GAME OR COMPETITION

If 1 recorded in 1.02c, go to 1.29.
Otherwise, go to instruction prior to 1.35.

[Showcard 1D]

1.29 You said that you played a text game or competition in the last 12 months. [I'll talk about the others in a moment.] About how often do you play a text game or competition? [Code one only]

- 1 Four times a week or more
- 2 Two or three times a week
- 3 Once a week
- 4 Once every two weeks
- 5 Once every three weeks
- 6 Once a month
- 7 Once every two months
- 8 Once every three months
- 9 Once every six months
- 10 Once a year
- 11 Less frequently than once a year

NOT ON SHOWCARD:

- .K Don't know
- .R Refused

1.30 When you play a text game or competition, how much do you usually spend in a typical month?

- ① RECORD TO THE NEAREST DOLLAR, EG, \$60 = 60
- ① DO NOT RECORD CENTS, EG, \$2.50 = 3
- ① IF RESPONDENTS SAYS BETWEEN TWO AMOUNTS, IE, \$40 TO \$50 RECORD THE AVERAGE 45
- ① ENTER NUMBERS ONLY; THAT IS, NO COMMAS, SYMBOLS OR LETTERS, EG, FOR \$10,000, ENTER 10000

\$ _____

- .K Don't know
- .R Refused

[Showcard 1E]

1.31 Which of the reasons on this card best describes why you play a text game or competition? You can choose as many as you like. [Code or record all mentioned]

- 1 To win prizes/money
- 2 For excitement/or a challenge
- 3 To support worthy causes
- 4 Out of curiosity
- 5 To oblige or please other people
- 6 As a gift for another person
- 7 As an interest/or a hobby
- 8 To be with people/get out of the house
- 9 As entertainment
- 77 Other reasons [**Specify**]: _____

NOT ON SHOWCARD:

- .K Don't know
- .R Refused

1.32 Thinking about playing a text game or competition, in the last twelve months would you say you have ...?

[Read out all and code one only]

- 1 Won money overall
- 2 Broken even
- 3 Lost money overall

DO NOT READ OUT:

- .K Don't know
- .R Refused

1.33 a. Do you use any system or special skills to improve your chances of winning a text game or competition? [Code one only]

- 1 Yes
- 5 No
- 98 Don't know/Don't know of any such system
- .R Refused

**If 1 recorded in 1.33a, go to 1.33b.
Otherwise go to instruction prior to 1.34.**

b. Could you please describe that to me? [Record verbatim]

.R Refused

BOUGHT A TICKET IN AN OVERSEAS RAFFLE OR LOTTERY (INCLUDES TICKETS BOUGHT IN AN OVERSEAS SHOP, BY TELEPHONE, THROUGH THE POST, OR ONLINE)

If 1 recorded in 1.02d, go to 1.34.

Otherwise, go to instruction prior to 1.35.

[Showcard 1D]

1.34 You said that you had bought a ticket in an overseas raffle or lottery, purchased in an overseas shop, by telephone, through the post and/or online, in the last 12 months. About how often do you buy a ticket in an overseas raffle or lottery, either by yourself or as part of a syndicate? [Code one only]

- 1 Four times a week or more
- 2 Two or three times a week
- 3 Once a week
- 4 Once every two weeks
- 5 Once every three weeks
- 6 Once a month
- 7 Once every two months
- 8 Once every three months
- 9 Once every six months
- 10 Once a year
- 11 Less frequently than once a year

NOT ON SHOWCARD:

.K Don't know

.R Refused

BOUGHT A TICKET IN A NZ RAFFLE OR LOTTERY (DOES NOT INCLUDE LOTTERIES COMMISSION GAMES: LOTTO; STRIKE; POWERBALL; BIG WEDNESDAY; KENO; BULLSEYE; OR INSTANT KIWI)

If 1 recorded in 1.02e, go to 1.35.
Otherwise, go to instruction prior to 1.41.

[Showcard 1D]

1.35 You said that you had bought a ticket in a NZ raffle or lottery (not including Lotteries Commission games: Lotto; Strike; Powerball; Big Wednesday; Keno; Bullseye; or Instant Kiwi) in the last 12 months. [I'll talk about the others in a moment.] About how often do you buy a ticket in a NZ raffle or lottery, either by yourself or as part of a syndicate? [Code one only]

- 1 Four times a week or more
- 2 Two or three times a week
- 3 Once a week
- 4 Once every two weeks
- 5 Once every three weeks
- 6 Once a month
- 7 Once every two months
- 8 Once every three months
- 9 Once every six months
- 10 Once a year
- 11 Less frequently than once a year

NOT ON SHOWCARD:

- .K Don't know
- .R Refused

1.36 When you buy a ticket in a NZ raffle or lottery either by yourself or as part of a syndicate, how much do you usually spend in a typical month?

- ① RECORD TO THE NEAREST DOLLAR, EG, \$60 = 60
- ① DO NOT RECORD CENTS, EG, \$2.50 = 3
- ① IF RESPONDENTS SAYS BETWEEN TWO AMOUNTS, IE, \$40 TO \$50 RECORD THE AVERAGE 45
- ① ENTER NUMBERS ONLY; THAT IS, NO COMMAS, SYMBOLS OR LETTERS, EG, FOR \$10,000, ENTER 10000

\$ _____

- .K Don't know
- .R Refused

[Showcard 1E]

1.37 Which of the reasons on this card best describes why you buy a ticket in a NZ raffle or lottery? You can choose as many as you like. [Code or record all mentioned]

- 1 To win prizes/money
- 2 For excitement/or a challenge
- 3 To support worthy causes
- 4 Out of curiosity
- 5 To oblige or please other people
- 6 As a gift for another person
- 7 As an interest/or a hobby
- 8 To be with people/get out of the house
- 9 As entertainment
- 77 Other reasons [**Specify**]: _____

NOT ON SHOWCARD:

- .K Don't know
- .R Refused

If only 6 selected go to instruction prior to 1.41.

1.38 Thinking about buying a ticket in a NZ raffle or lottery, in the last twelve months would you say you have ...? [Read out all and code one only]

- 1 Won money overall
- 2 Broken even
- 3 Lost money overall

DO NOT READ OUT:

- 4 Raffle not yet drawn
- .K Don't know
- .R Refused

1.39 Do you use any system or special skills to improve your chances of buying a winning ticket in a NZ raffle or lottery? [Code one only]

- 1 Yes
- 5 No
- 98 Don't know/Don't know of any such system
- .R Refused

**If 1 recorded in 1.39, go to 1.40.
Otherwise go to instruction prior to 1.41.**

1.40 Could you please describe that to me? [Record verbatim]

.R Refused

BOUGHT A LOTTERIES COMMISSION LOTTO TICKET (THIS INCLUDES STRIKE; POWERBALL; BIG WEDNESDAY)

**If 1 recorded in 1.03a, go to 1.41.
Otherwise, go to instruction prior to 1.49.**

[Showcard 1F]

1.41 You said that you had bought a Lotteries Commission Lotto ticket in the last 12 months. This can be done online or in person from a store.

[I'll talk about the others in a moment. Programmer: Only insert if 5 selected in all of 1.02. If only one Yes ① recorded in 1.02 and 1.04 do not insert.] Firstly, about how often do you buy Lotto tickets online from the MyLotto website, either by yourself or as part of a syndicate? [Code one only]

- 1 Four times a week or more → GO TO 1.42
- 2 Two or three times a week
- 3 Once a week
- 4 Once every two weeks
- 5 Once every three weeks
- 6 Once a month
- 7 Once every two months
- 8 Once every three months
- 9 Once every six months
- 10 Once a year
- 11 Less frequently than once a year
- 95 Never → GO TO 1.43
- .K Don't know → GO TO 1.42
- .R Refused → GO TO 1.43

1.42 When you buy Lotto tickets either by yourself or as part of a syndicate online from the MyLotto website, how much do you usually spend in a typical month?

- ① RECORD TO THE NEAREST DOLLAR, EG, \$60 = 60
- ① DO NOT RECORD CENTS, EG, \$2.50 = 3
- ① IF RESPONDENTS SAYS BETWEEN TWO AMOUNTS, IE, \$40 TO \$50 RECORD THE AVERAGE 45
- ① ENTER NUMBERS ONLY; THAT IS, NO COMMAS, SYMBOLS OR LETTERS, EG, FOR \$10,000, ENTER 10000

- \$ _____
- .K Don't know
- .R Refused

[Showcard 1F]

1.43 About how often do you buy Lotto tickets from a store, either by yourself, as part of a syndicate, or someone buys one on your behalf? This includes situations where you are part of a syndicate but you do not personally purchase the ticket (another member of your syndicate does). [Code one only]

- 1 Four times a week or more → GO TO 1.44
- 2 Two or three times a week
- 3 Once a week
- 4 Once every two weeks
- 5 Once every three weeks
- 6 Once a month
- 7 Once every two months
- 8 Once every three months
- 9 Once every six months
- 10 Once a year
- 11 Less frequently than once a year
- 95 Never → GO TO 1.45

NOT ON SHOWCARD:	
.K Don't know	→ GO TO 1.44
.R Refused	→ GO TO 1.45

Programmer: If 1.03a = 1 then 1.41 and 1.43 can't both = 95.

1.44 When you buy Lotto tickets either by yourself or as part of a syndicate in person from a store, how much do you usually spend in a typical month?

- ① RECORD TO THE NEAREST DOLLAR, EG, \$60 = 60
- ① DO NOT RECORD CENTS, EG, \$2.50 = 3
- ① IF RESPONDENTS SAYS BETWEEN TWO AMOUNTS, IE, \$40 TO \$50 RECORD THE AVERAGE 45
- ① ENTER NUMBERS ONLY; THAT IS, NO COMMAS, SYMBOLS OR LETTERS, EG, FOR \$10,000, ENTER 10000
- \$ _____
- .K Don't know
- .R Refused

[Showcard 1E]

1.45 Which of the reasons on this card best describes why you buy Lotto tickets? You can choose as many as you like. [Code or record all mentioned]

- 1 To win prizes/money
- 2 For excitement/or a challenge
- 3 To support worthy causes
- 4 Out of curiosity
- 5 To oblige or please other people
- 6 As a gift for another person
- 7 As an interest/or a hobby
- 8 To be with people/get out of the house
- 9 As entertainment
- 77 Other reasons [Specify]: _____

NOT ON SHOWCARD:	
.K Don't know	
.R Refused	

If only 6 selected go to instruction prior to 1.49.

**1.46 Thinking about Lotto, in the last twelve months would you say you have ...?
[Read out all and code one only]**

- 1 Won money overall
- 2 Broken even
- 3 Lost money overall

DO NOT READ OUT:

- .K Don't know
- .R Refused

1.47 Do you use any system or special skills to improve your chances of winning at Lotto? [Code one only]

- 1 Yes
- 5 No
- 98 Don't know/Don't know of any such system
- .R Refused

**If 1 recorded in 1.47, go to 1.48.
Otherwise go to instruction prior to 1.49.**

1.48 Could you please describe that to me? [Record verbatim]

.R Refused

BOUGHT A LOTTERIES COMMISSION KENO TICKET

If 1 recorded in 1.03b, go to 1.49.
Otherwise, go to instruction prior to 1.57.

[Showcard 1F]

1.49 You said that you had bought a Lotteries Commission Keno ticket in the last 12 months. This can be done online or in person from a store. [I'll talk about the others in a moment.] Firstly, about how often do you buy Keno tickets online from the MyLotto website? [Code one only]

- 1 Four times a week or more → GO TO 1.50
- 2 Two or three times a week
- 3 Once a week
- 4 Once every two weeks
- 5 Once every three weeks
- 6 Once a month
- 7 Once every two months
- 8 Once every three months
- 9 Once every six months
- 10 Once a year
- 11 Less frequently than once a year
- 95 Never → GO TO 1.51

NOT ON SHOWCARD:

- .K Don't know → GO TO 1.50
- .R Refused → GO TO 1.51

1.50 When you buy Keno tickets online from the MyLotto website, how much do you usually spend in a typical month?

- ① RECORD TO THE NEAREST DOLLAR, EG, \$60 = 60
- ① DO NOT RECORD CENTS, EG, \$2.50 = 3
- ① IF RESPONDENTS SAYS BETWEEN TWO AMOUNTS, IE, \$40 TO \$50 RECORD THE AVERAGE 45
- ① ENTER NUMBERS ONLY; THAT IS, NO COMMAS, SYMBOLS OR LETTERS, EG, FOR \$10,000, ENTER 10000

- \$ _____
- .K Don't know
 - .R Refused

[Showcard 1F]

1.51 About how often do you buy Keno tickets in person from a store? [Code one only]

- 1 Four times a week or more → GO TO 1.52
- 2 Two or three times a week
- 3 Once a week
- 4 Once every two weeks
- 5 Once every three weeks
- 6 Once a month
- 7 Once every two months
- 8 Once every three months
- 9 Once every six months
- 10 Once a year
- 11 Less frequently than once a year
- 95 Never → GO TO 1.53

NOT ON SHOWCARD:

.K Don't know → GO TO 1.52

.R Refused → GO TO 1.53

Programmer: If 1.04b = 1 then 1.49 and 1.51 can't both = 95.

1.52 When you buy Keno tickets in person from a store, how much do you usually spend in a typical month?

- ① RECORD TO THE NEAREST DOLLAR, EG, \$60 = 60
- ① DO NOT RECORD CENTS, EG, \$2.50 = 3
- ① IF RESPONDENTS SAYS BETWEEN TWO AMOUNTS, IE, \$40 TO \$50 RECORD THE AVERAGE 45
- ① ENTER NUMBERS ONLY; THAT IS, NO COMMAS, SYMBOLS OR LETTERS, EG, FOR \$10,000, ENTER 10000
- \$ _____
- .K Don't know
- .R Refused

[Showcard 1E]

1.53 Which of the reasons on this card best describes why you buy Keno tickets? You can choose as many as you like. [Code or record all mentioned]

- 1 To win prizes/money
- 2 For excitement/or a challenge
- 3 To support worthy causes
- 4 Out of curiosity
- 5 To oblige or please other people
- 6 As a gift for another person
- 7 As an interest/or a hobby
- 8 To be with people/get out of the house
- 9 As entertainment
- 77 Other reasons [Specify]: _____

NOT ON SHOWCARD:

.K Don't know

.R Refused

If only 6 selected in 1.53 go to instruction prior to 1.57.

1.54 Thinking about Keno, in the last twelve months would you say you have...? [Read out all and code one only]

- 1 Won money overall
- 2 Broken even
- 3 Lost money overall

DO NOT READ OUT:

- .K Don't know
- .R Refused

1.55 a. Do you use any system or special skills to improve your chances of winning at Keno? [Code one only]

- 1 Yes
- 5 No
- 98 Don't know/Don't know of any such system
- .R Refused

**If 1 recorded in 1.55a, go to 1.55b.
Otherwise go to instruction prior to 1.56.**

b. Could you please describe that to me? [Record verbatim]

.R Refused

BOUGHT A LOTTERIES COMMISSION BULLSEYE TICKET

If 1 recorded in 1.03c, go to 1.56.

Otherwise, go to instruction prior to 1.57.

[Showcard 1D]

1.56 You said that you had bought a Lotteries Commission Bullseye ticket, in the last 12 months. About how often do you buy a Bullseye ticket, either by yourself or as part of a syndicate? [Code one only]

- 1 Four times a week or more
- 2 Two or three times a week
- 3 Once a week
- 4 Once every two weeks
- 5 Once every three weeks
- 6 Once a month
- 7 Once every two months
- 8 Once every three months
- 9 Once every six months
- 10 Once a year
- 11 Less frequently than once a year

NOT ON SHOWCARD:

.K Don't know

.R Refused

BOUGHT INSTANT KIWI TICKETS (INCLUDE OTHER SCRATCH TICKETS)

**If 1 recorded in 1.03d, go to 1.57.
Otherwise, go to instruction prior to 1.63.**

[Showcard 1D]

1.57 You said that you had bought an Instant Kiwi ticket, or other Scratch ticket, in the last 12 months. [I'll talk about the others in a moment.] About how often do you buy Instant Kiwi tickets or other Scratch tickets either by yourself or as part of a syndicate? [Code one only]

- 1 Four times a week or more
- 2 Two or three times a week
- 3 Once a week
- 4 Once every two weeks
- 5 Once every three weeks
- 6 Once a month
- 7 Once every two months
- 8 Once every three months
- 9 Once every six months
- 10 Once a year
- 11 Less frequently than once a year

NOT ON SHOWCARD: .K Don't know .R Refused

1.58 When you buy Instant Kiwi or other Scratch tickets either by yourself or as part of a syndicate, how much do you usually spend in a typical month?

- ① RECORD TO THE NEAREST DOLLAR, EG, \$60 = 60
 - ① DO NOT RECORD CENTS, EG, \$2.50 = 3
 - ① IF RESPONDENTS SAYS BETWEEN TWO AMOUNTS, IE, \$40 TO \$50 RECORD THE AVERAGE 45
 - ① ENTER NUMBERS ONLY; THAT IS, NO COMMAS, SYMBOLS OR LETTERS, EG, FOR \$10,000, ENTER 10000
- \$ _____
- .K Don't know
 - .R Refused

[Showcard 1E]

1.59 Which of the reasons on this card best describes why you buy Instant Kiwi or other Scratch tickets? You can choose as many as you like. [Code or record all mentioned]

- 1 To win prizes/money
- 2 For excitement/or a challenge
- 3 To support worthy causes
- 4 Out of curiosity
- 5 To oblige or please other people
- 6 As a gift for another person
- 7 As an interest/or a hobby
- 8 To be with people/get out of the house
- 9 As entertainment
- 77 Other reasons [**Specify**]: _____

NOT ON SHOWCARD: .K Don't know .R Refused

If only 6 selected go to instruction prior to 1.63.

1.60 Thinking about Instant Kiwi or other Scratch tickets, in the last twelve months would you say you have...? [Read out all and code one only]

- 1 Won money overall
- 2 Broken even
- 3 Lost money overall

DO NOT READ OUT:

- .K Don't know
- .R Refused

1.61 Do you use any system or special skills to improve your chances of winning with Instant Kiwi or other Scratch tickets? [Code one only]

- 1 Yes
- 5 No
- 98 Don't know/Don't know of any such system
- .R Refused

**If 1 recorded in 1.61, go to 1.62.
Otherwise go to instruction prior to 1.63.**

1.62 Could you please describe that to me? [Record verbatim]

- .R Refused

PLAYED HOUSIE OR BINGO IN THE LAST 12 MONTHS

If 1 recorded in 1.03e, go to 1.63.
Otherwise, go to instruction prior to 1.69.

[Showcard 1D]

1.63 You said that you had played housie or bingo in the last 12 months. [I'll talk about the others in a moment.] About how often do you play a session of housie or bingo?

① PROBE: 'One session means all the games you took part in at one time, eg, in one evening.'

[Code one only]

- 1 Four times a week or more
- 2 Two or three times a week
- 3 Once a week
- 4 Once every two weeks
- 5 Once every three weeks
- 6 Once a month
- 7 Once every two months
- 8 Once every three months
- 9 Once every six months
- 10 Once a year
- 11 Less frequently than once a year

NOT ON SHOWCARD:

- .K Don't know
- .R Refused

1.64 Can you tell me how much you would normally spend in a typical month?

① RECORD TO THE NEAREST DOLLAR, EG, \$60 = 60

① DO NOT RECORD CENTS, EG, \$2.50 = 3

① IF RESPONDENTS SAYS BETWEEN TWO AMOUNTS, IE, \$40 TO \$50 RECORD THE AVERAGE 45

① ENTER NUMBERS ONLY; THAT IS, NO COMMAS, SYMBOLS OR LETTERS,
EG, FOR \$10,000, ENTER 10000

\$ _____

- .K Don't know
- .R Refused

[Showcard 1E]

1.65 Which of the reasons on this card best describes why you play housie or bingo? You can choose as many as you like. [Code or record all mentioned]

- 1 To win prizes/money
- 2 For excitement/or a challenge
- 3 To support worthy causes
- 4 Out of curiosity
- 5 To oblige or please other people
- 6 As a gift for another person
- 7 As an interest/or a hobby
- 8 To be with people/get out of the house
- 9 As entertainment
- 77 Other reasons [**Specify**]: _____

NOT ON SHOWCARD:

- .K Don't know
- .R Refused

1.66 Thinking about housie or bingo, in the last twelve months would you say you have...?
[Read out all and code one only]

- 1 Won money overall
- 2 Broken even
- 3 Lost money overall

DO NOT READ OUT:

- .K Don't know
- .R Refused

1.67 Do you use any system or special skills to improve your chances of winning at housie or bingo?
[Code one only]

- 1 Yes
- 5 No
- 98 Don't know/Don't know of any such system
- .R Refused

If 1 recorded in 1.67, go to 1.68.
Otherwise go to instruction prior to 1.69.

1.68 Could you please describe that to me? [Record verbatim]

- .R Refused

BET MONEY ON A HORSE OR DOG RACE IN THE LAST 12 MONTHS

If 1 recorded in 1.03f, go to 1.69.
 Otherwise, go to interviewer instruction prior to 1.88.

[Showcard 1F]

1.69 You said that you had bet on a horse or dog race in the last 12 months. This can be done at the track, in person at the TAB, by phone, online and/or through an overseas betting organisation or website. [I'll talk about the others in a moment.] Firstly, about how often do you go to a racetrack and place money on horse or dog races, while you are actually at the track?
 [Code one only]

- 1 Four times a week or more → GO TO 1.70
- 2 Two or three times a week
- 3 Once a week
- 4 Once every two weeks
- 5 Once every three weeks
- 6 Once a month
- 7 Once every two months
- 8 Once every three months
- 9 Once every six months
- 10 Once a year
- 11 Less frequently than once a year
- 95 Never → GO TO 1.73

NOT ON SHOWCARD:	
.K Don't know	→ GO TO 1.70
.R Refused	→ GO TO 1.73

1.70 When you go to a race track and place money on horse or dog races, about how much do you bet in a typical month?

- ① RECORD TO THE NEAREST DOLLAR, EG, \$60 = 60
- ① DO NOT RECORD CENTS, EG, \$2.50 = 3
- ① IF RESPONDENTS SAYS BETWEEN TWO AMOUNTS, IE, \$40 TO \$50 RECORD THE AVERAGE 45
- ① ENTER NUMBERS ONLY; THAT IS, NO COMMAS, SYMBOLS OR LETTERS, EG, FOR \$10,000, ENTER 10000
- \$ _____
- .K Don't know
- .R Refused

[Showcard 1E]

1.71 Which of the reasons on this card best describes why you go to a race track and place money on horse or dog races? You can choose as many as you like. [Code or record all mentioned]

- 1 To win prizes/money
- 2 For excitement/or a challenge
- 3 To support worthy causes
- 4 Out of curiosity
- 5 To oblige or please other people
- 6 As a gift for another person
- 7 As an interest/or a hobby
- 8 To be with people/get out of the house
- 9 As entertainment
- 77 Other reasons [Specify]: _____

NOT ON SHOWCARD:	
.K Don't know	
.R Refused	

1.72 Thinking about going to a race track and placing money on horse or dog races, in the last twelve months would you say you have...?
[Read out all and code one only]

- 1 Won money overall
- 2 Broken even
- 3 Lost money overall

DO NOT READ OUT:

- .K Don't know
- .R Refused

TAB BETS

We have already asked you about your betting when you actually visited a racetrack. The next question is about bets on horse or dog races, that you made in person through the New Zealand TAB. This includes bets made at a TAB outlet and a TAB in a pub or club.

[Showcard 1F]

1.73 About how often do you place money on horse or dog races in person through the New Zealand TAB? [Code one only]

① THIS CAN BE DONE BY ANOTHER PERSON, ON BEHALF OF THE RESPONDENT. FOR EXAMPLE THE RESPONDENT MAY GET THEIR SON TO PLACE THE BET.

- 1 Four times a week or more → GO TO 1.74
- 2 Two or three times a week
- 3 Once a week
- 4 Once every two weeks
- 5 Once every three weeks
- 6 Once a month
- 7 Once every two months
- 8 Once every three months
- 9 Once every six months
- 10 Once a year
- 11 Less frequently than once a year
- 95 Never → GO TO 1.77

NOT ON SHOWCARD:

- .K Don't know → GO TO 1.74
- .R Refused → GO TO 1.77

1.74 When you place money on horse or dog races in person through the New Zealand TAB, about how much do you bet in a typical month?

- ① RECORD TO THE NEAREST DOLLAR, EG, \$60 = 60
- ① DO NOT RECORD CENTS, EG, \$2.50 = 3
- ① IF RESPONDENTS SAYS BETWEEN TWO AMOUNTS, IE, \$40 TO \$50 RECORD THE AVERAGE 45
- ① ENTER NUMBERS ONLY; THAT IS, NO COMMAS, SYMBOLS OR LETTERS, EG, FOR \$10,000, ENTER 10000

- \$ _____
- .K Don't know
 - .R Refused

[Showcard 1E]

1.75 Which of the reasons on this card best describes why you place money on horse or dog races in person through the New Zealand TAB? You can choose as many as you like. [Code or record all mentioned]

- 1 To win prizes/money
- 2 For excitement/or a challenge
- 3 To support worthy causes
- 4 Out of curiosity
- 5 To oblige or please other people
- 6 As a gift for another person
- 7 As an interest/or a hobby
- 8 To be with people/get out of the house
- 9 As entertainment
- 77 Other reasons **[Specify]:** _____

NOT ON SHOWCARD:

- .K Don't know
- .R Refused

1.76 Thinking about placing money on horse or dog races in person through the New Zealand TAB, in the last twelve months would you say you have...? [Read out all and code one only]

- 1 Won money overall
- 2 Broken even
- 3 Lost money overall

DO NOT READ OUT:

- .K Don't know
- .R Refused

[Showcard 1G]

We have already asked you about your betting when you actually visited a racetrack and in person through a New Zealand TAB. The next question is about all other bets on horse or dog races, that you made through the New Zealand TAB.

Please take time now to look at Card 1G as this helps explain what this does and does not include.

[Showcard 1H]

1.77 About how often do you place money on horse or dog races through the New Zealand TAB by telephone, online or SKYbet interactive TV? [Code one only]

① NOTE: IF ASKED SKYbet CLOSED DOWN ON 15/8/2011

- 1 Four times a week or more → GO TO 1.78
- 2 Two or three times a week
- 3 Once a week
- 4 Once every two weeks
- 5 Once every three weeks
- 6 Once a month
- 7 Once every two months
- 8 Once every three months
- 9 Once every six months
- 10 Once a year
- 11 Less frequently than once a year
- 95 Never → GO TO 1.81

NOT ON SHOWCARD:

- .K Don't know → GO TO 1.78
- .R Refused → GO TO 1.81

1.78 When you place money on horse or dog races through the New Zealand TAB by telephone, online or SKYbet interactive TV, about how much do you bet in a typical month?

① RECORD TO THE NEAREST DOLLAR, EG, \$60 = 60

① DO NOT RECORD CENTS, EG, \$2.50 = 3

① IF RESPONDENTS SAYS BETWEEN TWO AMOUNTS, IE, \$40 TO \$50 RECORD THE AVERAGE 45

① ENTER NUMBERS ONLY; THAT IS, NO COMMAS, SYMBOLS OR LETTERS, EG, FOR \$10,000, ENTER 10000

\$ _____

- .K Don't know
- .R Refused

[Showcard 1I]

1.79 Which of the reasons on this card best describes why you place money on horse or dog races through the New Zealand TAB by telephone, online or SKYbet interactive TV? You can choose as many as you like. [Code or record all mentioned]

- 1 To win prizes/money
- 2 For excitement/or a challenge
- 3 To support worthy causes
- 4 Out of curiosity
- 5 To oblige or please other people
- 6 As a gift for another person
- 7 As an interest/or a hobby
- 8 To be with people/get out of the house
- 9 As entertainment
- 77 Other reasons [**Specify**]: _____

NOT ON SHOWCARD: .K Don't know .R Refused

1.80 Thinking about placing money on horse or dog races in person through the New Zealand TAB by telephone, online or SKYbet interactive TV, in the last twelve months would you say you have...? [Read out all and code one only]

- 1 Won money overall
- 2 Broken even
- 3 Lost money overall

DO NOT READ OUT: .K Don't know .R Refused

HORSE OR DOG RACES THROUGH AN OVERSEAS BETTING ORGANISATION OR OVERSEAS TAB

[Showcard 1J]

1.81 About how often do you place money on horse or dog races through an overseas betting organisation or an overseas TAB by telephone, or online (eg, via the internet through a PC, laptop, iPad, iPhone, or other handheld device), or interactive TV? [Code one only]

- 1 Four times a week or more → GO TO 1.82
- 2 Two or three times a week
- 3 Once a week
- 4 Once every two weeks
- 5 Once every three weeks
- 6 Once a month
- 7 Once every two months
- 8 Once every three months
- 9 Once every six months
- 10 Once a year
- 11 Less frequently than once a year
- 95 Never → GO TO INSTRUCTION PRIOR TO 1.85

NOT ON SHOWCARD:

- .K Don't know → GO TO 1.82
- .R Refused → GO TO INSTRUCTION PRIOR TO 1.85

Programmer: If 1.03f = 1 then 1.69 and 1.73, 1.77 and 1.81 cannot all = 95.

1.82 When you place money on horse or dog races through an overseas betting organisation or an overseas TAB, about how much would you bet in a typical month?

- ① RECORD TO THE NEAREST DOLLAR, EG, \$60 = 60
- ① DO NOT RECORD CENTS, EG, \$2.50 = 3
- ① IF RESPONDENTS SAYS BETWEEN TWO AMOUNTS, IE, \$40 TO \$50 RECORD THE AVERAGE 45
- ① ENTER NUMBERS ONLY; THAT IS, NO COMMAS, SYMBOLS OR LETTERS, EG, FOR \$10,000, ENTER 10000
- \$ _____
- .K Don't know
- .R Refused

[Showcard 1I]

1.83 Which of the reasons on this card best describes why you place money on horse or dog races through an overseas betting organisation or an overseas TAB? [Code or record all mentioned]

- 1 To win prizes/money
- 2 For excitement/or a challenge
- 3 To support worthy causes
- 4 Out of curiosity
- 5 To oblige or please other people
- 6 As a gift for another person
- 7 As an interest/or a hobby
- 8 To be with people/get out of the house
- 9 As entertainment
- 77 Other reasons [Specify]: _____

NOT ON SHOWCARD:

- .K Don't know
- .R Refused

1.84 Thinking about placing money on horse or dog races through an overseas betting organisation or an overseas TAB, in the last twelve months would you say you have...?
[Read out all and code one only]

- 1 Won money overall
- 2 Broken even
- 3 Lost money overall

DO NOT READ OUT:

- .K Don't know
- .R Refused

Routing Instruction for 95, .R .K

- 1. If 95 selected in three of 1.69, 1.73, 1.77 or 1.81. Go to 1.86.**
- 2. If . R selected in three or more of 1.69, 1.73, 1.77 or 1.81. Go to 1.86.**
- 3. If .K selected in three or more of 1.69, 1.73, 1.77 or 1.81. Go to 1.85.**

[Showcard 1K]

1.85 Thinking about all the ways of betting on horse or dog races (at the track, New Zealand TAB, overseas betting organisation or overseas TAB), about how often do you place money on horse or dog races overall? [Code one only]

Programmer: Answer cannot be less than answer in 1.69, 1.73, 1.77 or 1.81.

- 1 Four times a week or more
- 2 Two or three times a week
- 3 Once a week or more
- 4 Once every two weeks
- 5 Once every three weeks
- 6 Once a month
- 7 Once every two months
- 8 Once every three months
- 9 Once every six months
- 10 Once a year
- 11 Less frequently than once a year

NOT ON SHOWCARD:

- .K Don't know
- .R Refused

1.86 Do you use any system or special skills to improve your chances of winning when you place money on horse or dog races? [Code one only]

- 1 Yes
- 5 No
- 98 Don't know/Don't know of any such system
- .R Refused

If 1 recorded in 1.86, go to 1.87.

Otherwise go to instruction prior to 1.88.

1.87 Could you please describe that to me? [Record verbatim]

-
- .R Refused

BET MONEY ON SPORTING EVENTS

If 1 recorded in 1.03g, go to 1.88.
Otherwise, go to instruction prior to 1.106.

[Showcard 1L/1M]

1.88 You said that you had bet on a sporting event in the last 12 months. [I'll talk about the others in a moment.] About how often do you place money on sporting events, other than horse or dog races, through the New Zealand TAB at a sporting event? Please take time now to look at Card 1L as this helps to explain what this does and does not include. [Code one only]

- 1 Four times a week or more → GO TO 1.89
- 2 Two or three times a week
- 3 Once a week
- 4 Once every two weeks
- 5 Once every three weeks
- 6 Once a month
- 7 Once every two months
- 8 Once every three months
- 9 Once every six months
- 10 Once a year
- 11 Less frequently than once a year
- 95 Never → GO TO 1.92

NOT ON SHOWCARD:

- .K Don't know → GO TO 1.89
- .R Refused → GO TO 1.92

1.89 When you place money on sporting events through the New Zealand TAB at a sporting event, how much do you bet in a typical month?

- Ⓛ RECORD TO THE NEAREST DOLLAR, EG, \$60 = 60
- Ⓛ DO NOT RECORD CENTS, EG, \$2.50 = 3
- Ⓛ IF RESPONDENTS SAYS BETWEEN TWO AMOUNTS, IE, \$40 TO \$50 RECORD THE AVERAGE 45
- Ⓛ ENTER NUMBERS ONLY; THAT IS, NO COMMAS, SYMBOLS OR LETTERS, EG, FOR \$10,000, ENTER 10000

\$ _____
.K Don't know
.R Refused

[Showcard 1N]

1.90 Which of the reasons on this card best describes why you place money on sporting events through the New Zealand TAB at a sporting event? [Code or record all mentioned]

- 1 To win prizes/money
- 2 For excitement/or a challenge
- 3 To support worthy causes
- 4 Out of curiosity
- 5 To oblige or please other people
- 6 As a gift for another person
- 7 As an interest/or a hobby
- 8 To be with people/get out of the house
- 9 As entertainment
- 77 Other reasons [Specify]: _____

NOT ON SHOWCARD:
 .K Don't know
 .R Refused

1.91 Thinking about betting on sports events through the New Zealand TAB at a sporting event, in the last twelve months, would you say you have? [Read out all and code one only]

- 1 Won money overall
- 2 Broken even
- 3 Lost money overall

DO NOT READ OUT:
 .K Don't know
 .R Refused

[Showcard 1O/1P]

1.92 About how often do you place money on sporting events, other than horse or dog races, through the New Zealand TAB in person at a TAB outlet or a TAB in a pub or club? Please take time now to look at Card 1O as this helps to explain what this does and does not include. [Code one only]

- 1 Four times a week or more → GO TO 1.93
- 2 Two or three times a week
- 3 Once a week
- 4 Once every two weeks
- 5 Once every three weeks
- 6 Once a month
- 7 Once every two months
- 8 Once every three months
- 9 Once every six months
- 10 Once a year
- 11 Less frequently than once a year
- 95 Never → GO TO 1.96

NOT ON SHOWCARD:

.K Don't know → GO TO 1.93

.R Refused → GO TO 1.96

1.93 When you place money on sporting events through the New Zealand TAB in person at a TAB outlet or a TAB in a pub or club, how much do you bet in a typical month?

① RECORD TO THE NEAREST DOLLAR, EG, \$60 = 60

① DO NOT RECORD CENTS, EG, \$2.50 = 3

① IF RESPONDENTS SAYS BETWEEN TWO AMOUNTS, IE, \$40 TO \$50 RECORD THE AVERAGE 45

① ENTER NUMBERS ONLY; THAT IS, NO COMMAS, SYMBOLS OR LETTERS,
EG, FOR \$10,000, ENTER 10000

\$ _____

.K Don't know

.R Refused

[Showcard 1N]

1.94 Which of the reasons on this card best describes why you place money on sporting events through the New Zealand TAB in person at a TAB outlet or a TAB in a pub or club,? [Code or record all mentioned]

- 1 To win prizes/money
- 2 For excitement/or a challenge
- 3 To support worthy causes
- 4 Out of curiosity
- 5 To oblige or please other people
- 6 As a gift for another person
- 7 As an interest/or a hobby
- 8 To be with people/get out of the house
- 9 As entertainment
- 77 Other reasons [**Specify**]: _____

NOT ON SHOWCARD:

.K Don't know

.R Refused

1.95 Thinking about betting on sports events through the New Zealand TAB in person at a TAB outlet or a TAB in a pub or club, in the last twelve months, would you say you have?
[Read out all and code one only]

- 1 Won money overall
- 2 Broken even
- 3 Lost money overall

DO NOT READ OUT:

.K Don't know

.R Refused

[Showcard 1Q/1R]

1.96 About how often do you place money on sporting events, other than horse or dog races, through the New Zealand TAB by telephone, online or SKYbet interactive TV. Please take time now to look at Card 1Q as this helps to explain what this does and does not include. [Code one only]

- 1 Four times a week or more → GO TO 1.97
- 2 Two or three times a week
- 3 Once a week
- 4 Once every two weeks
- 5 Once every three weeks
- 6 Once a month
- 7 Once every two months
- 8 Once every three months
- 9 Once every six months
- 10 Once a year
- 11 Less frequently than once a year
- 95 Never → GO TO 1.100

NOT ON SHOWCARD:	
.K Don't know	→ GO TO 1.97
.R Refused	→ GO TO 1.100

1.97 When you place money on sporting events through the New Zealand TAB by telephone, online or SKYbet interactive TV, how much do you bet in a typical month?

- ① RECORD TO THE NEAREST DOLLAR, EG, \$60 = 60
- ① DO NOT RECORD CENTS, EG, \$2.50 = 3
- ① IF RESPONDENTS SAYS BETWEEN TWO AMOUNTS, IE, \$40 TO \$50 RECORD THE AVERAGE 45
- ① ENTER NUMBERS ONLY; THAT IS, NO COMMAS, SYMBOLS OR LETTERS, EG, FOR \$10,000, ENTER 10000
- \$ _____
- .K Don't know
- .R Refused

[Showcard 1S]

1.98 Which of the reasons on this card best describes why you place money on sporting events through the New Zealand TAB by telephone, online or SKYbet interactive TV? [Code or record all mentioned]

- 1 To win prizes/money
- 2 For excitement/or a challenge
- 3 To support worthy causes
- 4 Out of curiosity
- 5 To oblige or please other people
- 6 As a gift for another person
- 7 As an interest/or a hobby
- 8 To be with people/get out of the house
- 9 As entertainment
- 77 Other reasons [**Specify**]: _____

NOT ON SHOWCARD:	
.K Don't know	
.R Refused	

1.99 Thinking about betting on sports events through the New Zealand TAB by telephone, online or SKYbet interactive TV, in the last twelve months would you say you have?
[Read out all and code one only]

- 1 Won money overall
- 2 Broken even
- 3 Lost money overall

DO NOT READ OUT:

- .K Don't know
- .R Refused

[Showcard 1R]

1.100 And about how often do you place money on sporting events, other than horse or dog races, through an overseas TAB or other overseas betting organisation or website? [Code one only]

- 1 Four times a week or more
- 2 Two or three times a week
- 3 Once a week
- 4 Once every two weeks
- 5 Once every three weeks
- 6 Once a month
- 7 Once every two months
- 8 Once every three months
- 9 Once every six months
- 10 Once a year
- 11 Less frequently than once a year
- 95 Never

GO TO 1.101

GO TO 1.104

NOT ON SHOWCARD:

.K Don't know

GO TO 1.101

.R Refused

GO TO 1.104

Programmer: If 1.03g = 1 then 1.88, 1.92, 1.96 and 1.100 can't all = 95.

1.101 When you place money on sporting events through an overseas TAB or other overseas betting organisation or website, how much do you bet in a typical month?

① RECORD TO THE NEAREST DOLLAR, EG, \$60 = 60

① DO NOT RECORD CENTS, EG, \$2.50 = 3

① IF RESPONDENTS SAYS BETWEEN TWO AMOUNTS, IE, \$40 TO \$50 RECORD THE AVERAGE 45

① ENTER NUMBERS ONLY; THAT IS, NO COMMAS, SYMBOLS OR LETTERS, EG, FOR \$10,000, ENTER 10000

\$ _____

- .K Don't know
- .R Refused

[Showcard 1S]

1.102 Which of the reasons on this card best describes why you place money on sporting events through an overseas TAB or other overseas betting organisation or website? [Code or record all mentioned]

- 1 To win prizes/money
- 2 For excitement/or a challenge
- 3 To support worthy causes
- 4 Out of curiosity
- 5 To oblige or please other people
- 6 As a gift for another person
- 7 As an interest/or a hobby
- 8 To be with people/get out of the house
- 9 As entertainment
- 77 Other reasons [**Specify**]: _____

NOT ON SHOWCARD:

- .K Don't know
- .R Refused

1.103 Thinking about betting on sports events through an overseas TAB or other overseas betting organisation or website, in the last twelve months would you say you have? [Read out all and code one only]

- 1 Won money overall
- 2 Broken even
- 3 Lost money overall

DO NOT READ OUT:

- .K Don't know
- .R Refused

1.104 Do you use any system or special skills to improve your chances of winning when you place money on sporting events? [Code one only]

- 1 Yes
- 5 No
- 98 Don't know/Don't know of any such system
- .R Refused

**If 1 recorded in 1.104, go to 1.105.
Otherwise go to instruction prior to 1.107.**

1.105 Could you please describe that to me? [Record verbatim]

-
- .R Refused

PLAYED A GAMING MACHINE OR POKIE, TABLE GAMES OR ANY OTHER GAMES AT AN OVERSEAS CASINO (IN PERSON, NOT ONLINE) FOR MONEY

If 1 recorded in 1.03h, go to 1.106.
Otherwise, go to instruction prior to 1.108.

[Showcard 1T]

1.106 You said that you played table games or pokies at an overseas casino (in person, not online) for money in the last 12 months. [I'll talk about the others in a moment.] About how often do you play table games or pokies at an overseas casino? [Code one only]

- 1 Four times a week or more
- 2 Two or three times a week
- 3 Once a week
- 4 Once every two weeks
- 5 Once every three weeks
- 6 Once a month
- 7 Once every two months
- 8 Once every three months
- 9 Once every six months
- 10 Once a year
- 11 Less frequently than once a year

NOT ON SHOWCARD: .K Don't know .R Refused

1.107 When you play table games or pokies at an overseas casino, how much do you usually spend in a typical month?

- ① RECORD TO THE NEAREST DOLLAR, EG, \$60 = 60
- ① DO NOT RECORD CENTS, EG, \$2.50 = 3
- ① IF RESPONDENTS SAYS BETWEEN TWO AMOUNTS, IE, \$40 TO \$50 RECORD THE AVERAGE 45
- ① ENTER NUMBERS ONLY; THAT IS, NO COMMAS, SYMBOLS OR LETTERS, EG, FOR \$10,000, ENTER 10000

\$ _____
.K Don't know
.R Refused

NEW ZEALAND CASINOS GENERAL

If 1 recorded in 1.03i, go to 1.108.
Otherwise, go to instruction prior to 1.124.

[Showcard 1T]

1.108 You said that you have played gaming machines or pokies, table games or other games at one of the six casinos in New Zealand in the last 12 months. About how often do you go to a NZ casino?
[Select one only]

- 1 Four times a week or more
- 2 Two or three times a week
- 3 Once a week
- 4 Once every two weeks
- 5 Once every three weeks
- 6 Once a month
- 7 Once every two months
- 8 Once every three months
- 9 Once every six months
- 10 Once a year
- 11 Less frequently than once a year

NOT ON SHOWCARD: .K Don't know .R Refused

1.109 Did this include ... [Read out and code one only]

- 1 Table games or other games
- 2 Gaming machine or pokies
- 3 Both

.K Don't know
.R Refused

GO TO INSTRUCTION PRIOR TO 1.124

If only 1 coded in 1.109, ask 1.110.
If only 2 coded in 1.109, ask 1.116.
If 3 coded in 1.109, ask both sets of questions.

PLAYED TABLE GAMES IN A CASINO

[Showcard 1T]

1.110 You said that you had played table games or other games not including gaming machines or pokies at one of the six casinos in New Zealand in the last 12 months. About how often do you play table games at a New Zealand casino? [Code one only]

- 1 Four times a week or more
- 2 Two or three times a week
- 3 Once a week
- 4 Once every two weeks
- 5 Once every three weeks
- 6 Once a month
- 7 Once every two months
- 8 Once every three months
- 9 Once every six months
- 10 Once a year
- 11 Less frequently than once a year

NOT ON SHOWCARD:

- .K Don't know
- .R Refused

1.111 When you play table games at a New Zealand casino about how much do you usually spend in a typical month?

① RECORD TO THE NEAREST DOLLAR, EG, \$60 = 60

① DO NOT RECORD CENTS, EG, \$2.50 = 3

① IF RESPONDENTS SAYS BETWEEN TWO AMOUNTS, IE, \$40 TO \$50 RECORD THE AVERAGE 45

① ENTER NUMBERS ONLY; THAT IS, NO COMMAS, SYMBOLS OR LETTERS, EG, FOR \$10,000, ENTER 10000

\$ _____

- .K Don't know
- .R Refused

[Showcard 1S]

1.112 Which of the reasons on this card best describes why you play table games at a New Zealand casino? [Code or record all mentioned]

- 1 To win prizes/money
- 2 For excitement/or a challenge
- 3 To support worthy causes
- 4 Out of curiosity
- 5 To oblige or please other people
- 6 As a gift for another person
- 7 As an interest/or a hobby
- 8 To be with people/get out of the house
- 9 As entertainment
- 77 Other reasons [**Specify**]: _____

NOT ON SHOWCARD:

- .K Don't know
- .R Refused

1.113 Thinking about playing table games at a New Zealand casino in the last twelve months would you say you have?
[Read out all and code one only]

- 1 Won money overall
- 2 Broken even
- 3 Lost money overall

DO NOT READ OUT:

- .K Don't know
- .R Refused

1.114 Do you use any system or special skills to improve your chances of winning at table games at a New Zealand casino? [Code one only]

- 1 Yes
- 5 No
- 98 Don't know/Don't know of any such system
- .R Refused

If 1 recorded in 1.114, go to 1.115, otherwise go to instruction prior to 1.116.

1.115 Could you please describe that to me? [Record verbatim]

-
- .R Refused

PLAYED GAMING MACHINES AT A NEW ZEALAND CASINO (NOT IN A PUB OR CLUB)

If 2 or 3 recorded in 1.109, go to 1.116.
Otherwise, go to instruction prior to 1.124.

[Showcard 1T]

1.116 You said that you had played gaming machines at a New Zealand casino in the last 12 months. By gaming machines I mean slot, poker, fruit machines, or one armed bandits. About how often do you play gaming machines at a New Zealand casino? [Code one only]

- 1 Four times a week or more
- 2 Two or three times a week
- 3 Once a week
- 4 Once every two weeks
- 5 Once every three weeks
- 6 Once a month
- 7 Once every two months
- 8 Once every three months
- 9 Once every six months
- 10 Once a year
- 11 Less frequently than once a year

NOT ON SHOWCARD:

- .K Don't know
- .R Refused

1.117 When you play gaming machines at a New Zealand casino, how much do you usually spend in a typical month?

① RECORD TO THE NEAREST DOLLAR, EG, \$60 = 60

① DO NOT RECORD CENTS, EG, \$2.50 = 3

① IF RESPONDENTS SAYS BETWEEN TWO AMOUNTS, IE, \$40 TO \$50 RECORD THE AVERAGE 45

① ENTER NUMBERS ONLY; THAT IS, NO COMMAS, SYMBOLS OR LETTERS,
EG, FOR \$10,000, ENTER 10000

\$ _____

- .K Don't know
- .R Refused

[Showcard 1U]

1.118 On an average day when you play gaming machines at a New Zealand casino, how long do you play for? [Code one only]

- 1 Up to 15 minutes
- 2 More than 15 minutes, and up to 30 minutes
- 3 More than 30 minutes, and up to one hour
- 4 More than one hour, and up to two hours
- 5 More than two hours, and up to three hours
- 6 More than three hours

DO NOT READ OUT:

- .K Don't know
- .R Refused

1.119 Thinking about playing gaming machines at a New Zealand casino, in the last twelve months would you say you have...? [Read out all and code one only]

- 1 Won money overall
- 2 Broken even
- 3 Lost money overall

DO NOT READ OUT:

- .K Don't know
- .R Refused

1.120 Do you use any system or special skills to improve your chances of winning at gaming machines at a New Zealand casino? [Code one only]

- 1 Yes
- 5 No
- 98 Don't know/Don't know of any such system
- .R Refused

If 1 recorded in 1.120, go to 1.121, otherwise go to 1.122.

1.121 Could you please describe that to me? [Record verbatim]

-
- .R Refused

[Showcard 1V]

1.122 Which of the reasons on this card best describes why you play gaming machines at a New Zealand casino? [Code or record all mentioned]

- 1 To win prizes/money
- 2 For excitement/or a challenge
- 3 To support worthy causes
- 4 Out of curiosity
- 5 To oblige or please other people
- 6 As a gift for another person
- 7 As an interest/or a hobby
- 8 To be with people/get out of the house
- 9 As entertainment
- 77 Other reasons [**Specify**]: _____

NOT ON SHOWCARD:

- .K Don't know
- .R Refused

If 1.03j and k #1 and 1.109 = 2 or 3, ask 1.123.
Otherwise, go to instruction prior to 1.124.

1.123 Why do you prefer to play gaming machines at a New Zealand casino, rather than playing gaming machines elsewhere (not at a casino)? [Record verbatim]

-
- .K Don't know
 - .R Refused

→ **Go to instruction prior to 1.124**

PLAYED GAMING MACHINES IN A PUB (NOT IN A CASINO OR CLUB)

If 1 recorded in 1.03j, go to 1.124.
Otherwise, go to instruction prior to 1.132.

[Showcard 1W]

1.124 You said that you had played gaming machines that were in a pub in the last 12 months. By gaming machines I mean slot, poker, fruit machines, or one armed bandits. About how often do you play gaming machines in a pub? [Code one only]

- 1 Four times a week or more
- 2 Two or three times a week
- 3 Once a week
- 4 Once every two weeks
- 5 Once every three weeks
- 6 Once a month
- 7 Once every two months
- 8 Once every three months
- 9 Once every six months
- 10 Once a year
- 11 Less frequently than once a year

NOT ON SHOWCARD: .K Don't know .R Refused

1.125 When you play gaming machines in a pub, how much do you usually spend in a typical month?

- ① RECORD TO THE NEAREST DOLLAR, EG, \$60 = 60
 - ① DO NOT RECORD CENTS, EG, \$2.50 = 3
 - ① IF RESPONDENTS SAYS BETWEEN TWO AMOUNTS, IE, \$40 TO \$50 RECORD THE AVERAGE 45
 - ① ENTER NUMBERS ONLY; THAT IS, NO COMMAS, SYMBOLS OR LETTERS, EG, FOR \$10,000, ENTER 10000
- \$ _____
- .K Don't know
 - .R Refused

[Showcard 1U]

1.126 On an average day when you play gaming machines in a pub, how long do you play for? [Code one only]

- 1 Up to 15 minutes
- 2 More than 15 minutes, and up to 30 minutes
- 3 More than 30 minutes, and up to one hour
- 4 More than one hour, and up to two hours
- 5 More than two hours, and up to three hours
- 6 More than three hours

DO NOT READ OUT: .K Don't know .R Refused

1.127 Thinking about playing gaming machines in a pub, in the last twelve months would you say you have...? [Read out all and code one only]

- 1 Won money overall
- 2 Broken even
- 3 Lost money overall

DO NOT READ OUT: .K Don't know .R Refused

1.128 Do you use any system or special skills to improve your chances of winning at pub gaming machines? [Code one only]

- 1 Yes
- 5 No
- 98 Don't know/Don't know of any such system
- .R Refused

If 1 recorded in 1.128, go to 1.129. Otherwise, go to 1.130.

1.129 Could you please describe that to me? [Record verbatim]

-
- .R Refused

[Showcard 1V]

1.130 Which of the reasons on this card best describes why you play pub gaming machines? [Code or record all mentioned]

- 1 To win prizes/money
- 2 For excitement/or a challenge
- 3 To support worthy causes
- 4 Out of curiosity
- 5 To oblige or please other people
- 6 As a gift for another person
- 7 As an interest/or a hobby
- 8 To be with people/get out of the house
- 9 As entertainment
- 77 Other reasons **[Specify]:** _____

NOT ON SHOWCARD:

- .K Don't know
- .R Refused

If 1.03i and k not selected, or if 1.03k ≠ 1 but 1.03i and 1.109=1 .K or .R ask 1.131. Otherwise, go to instruction prior to 1.132.

1.131 Why do you prefer to play gaming machines at a pub, rather than playing gaming machines elsewhere (at a casino or club)? [Record verbatim]

-
- .K Don't know
 - .R Refused

→ **Go to instruction prior to 1.132**

PLAYED GAMING MACHINES IN A CLUB (NOT IN A CASINO OR PUB)

If 1 recorded in 1.03k, go to 1.132.
Otherwise, go to instruction prior to 1.140.

[Showcard 1W]

1.132 You said that you had played gaming machines that were in a club in the last 12 months. By gaming machines I mean slot, poker, fruit machines, or one armed bandits. About how often do you play gaming machines in a club? [Code one only]

- 1 Four times a week or more
- 2 Two or three times a week
- 3 Once a week
- 4 Once every two weeks
- 5 Once every three weeks
- 6 Once a month
- 7 Once every two months
- 8 Once every three months
- 9 Once every six months
- 10 Once a year
- 11 Less frequently than once a year

NOT ON SHOWCARD: .K Don't know .R Refused

1.133 When you play gaming machines in a club, how much do you usually spend in a typical month?

- ① RECORD TO THE NEAREST DOLLAR, EG, \$60 = 60
 - ① DO NOT RECORD CENTS, EG, \$2.50 = 3
 - ① IF RESPONDENTS SAYS BETWEEN TWO AMOUNTS, IE, \$40 TO \$50 RECORD THE AVERAGE 45
 - ① ENTER NUMBERS ONLY; THAT IS, NO COMMAS, SYMBOLS OR LETTERS, EG, FOR \$10,000, ENTER 10000
- \$ _____
- .K Don't know
 - .R Refused

[Showcard 1U]

1.134 On an average day when you play gaming machines in a club, how long do you play for? [Code one only]

- 1 Up to 15 minutes
- 2 More than 15 minutes, and up to 30 minutes
- 3 More than 30 minutes, and up to one hour
- 4 More than one hour, and up to two hours
- 5 More than two hours, and up to three hours
- 6 More than three hours

DO NOT READ OUT: .K Don't know .R Refused

1.135 Thinking about playing gaming machines in a club, in the last twelve months would you say you have...? [Read out all and code one only]

- 1 Won money overall
- 2 Broken even
- 3 Lost money overall

DO NOT READ OUT: .K Don't know .R Refused

1.136 Do you use any system or special skills to improve your chances of winning at club gaming machines? [Code one only]

- 1 Yes
- 5 No
- 98 Don't know/Don't know of any such system
- .R Refused

If 1 recorded in 1.136, go to 1.137. Otherwise, go to 1.138.

1.137 Could you please describe that to me? [Record verbatim]

.R Refused

[Showcard 1V]

1.138 Which of the reasons on this card best describes why you play club gaming machines? [Code or record all mentioned]

- 1 To win prizes/money
- 2 For excitement/or a challenge
- 3 To support worthy causes
- 4 Out of curiosity
- 5 To oblige or please other people
- 6 As a gift for another person
- 7 As an interest/or a hobby
- 8 To be with people/get out of the house
- 9 As entertainment
- 77 Other reasons **[Specify]:** _____

NOT ON SHOWCARD:

- .K Don't know
- .R Refused

If 1.03i and j ≠ 1, or if 1.03j not selected but 1.03i=1 and 1.109 = 1 or .K or .R, ask 1.139. Otherwise, go to instruction prior to 1.140.

1.139 Why do you prefer to play gaming machines at a club, rather than playing gaming machines elsewhere (at a casino or pub)? [Record verbatim]

.K Don't know
.R Refused

If 1.109 = 2 or 3 and 1.03j and/or 1.03k = 1, ask 1.140. Otherwise, go to instruction prior to 1.143.

[Showcard 1X]

1.140 Where do you prefer to play gaming machines? [Read out all and code one only]

- 1 At one of the six casinos
 - 2 Not at a casino (eg, at a pub or club)
 - 3 I have no preference either way
- GO TO 1.141
- GO TO 1.142

DO NOT READ OUT:

- .K Don't know
- .R Refused

1.141 Why is that? [Record verbatim]

.K Don't know
.R Refused

If 1.109 = 2 or 3 and 1.03j and/or 1.03k = 1, ask 1.142 or if 1.03i = 1 and 1.109 ≠ 2 or 3 but 1.03j and 1.03k both equal 1 ask 1.142.
Otherwise, go to instruction prior to 1.143.

[Showcard 1W]

1.142 Thinking of all the ways of playing gaming machines (in a casino, in a pub, in a club), about how often do you play gaming machines? [Code one only]

- 1 Four times a week or more
- 2 Two or three times a week
- 3 Once a week
- 4 Once every two weeks
- 5 Once every three weeks
- 6 Once a month
- 7 Once every two months
- 8 Once every three months
- 9 Once every six months
- 10 Once a year
- 11 Less frequently than once a year

NOT ON SHOWCARD:
.K Don't know
.R Refused

GO TO INSTRUCTION
PRIOR TO 1.143

Programmer: Answer cannot be less than answer given in 1.116, 1.124 or 1.132.

MADE SHORT-TERM SPECULATIVE INVESTMENTS LIKE DAY TRADING IN STOCKS AND SHARES

If 1 recorded in 1.03I, go to 1.143.
Otherwise, go to 1.150.

1.143 You said that you had made short-term speculative investments like day trading in stocks and shares in the last 12 months. Were your speculative investments made mostly ... [Read out and code one only]

- 1 Online
- 2 Through a broker
- 3 Both online and through a broker
- 77 Or by some other method [Specify]: _____

DO NOT READ OUT: .K Don't know .R Refused

[Showcard 1W]

1.144 About how often do you make short-term speculative investments? [Code one only]

- 1 Four times a week or more
- 2 Two or three times a week
- 3 Once a week
- 4 Once every two weeks
- 5 Once every three weeks
- 6 Once a month
- 7 Once every two months
- 8 Once every three months
- 9 Once every six months
- 10 Once a year
- 11 Less frequently than once a year

NOT ON SHOWCARD: .K Don't know .R Refused

1.145 When you make short-term speculative investments, how much do you usually spend in a typical month?

- ① RECORD TO THE NEAREST DOLLAR, EG, \$60 = 60
- ① DO NOT RECORD CENTS, EG, \$2.50 = 3
- ① IF RESPONDENTS SAYS BETWEEN TWO AMOUNTS, IE, \$40 TO \$50 RECORD THE AVERAGE 45
- ① ENTER NUMBERS ONLY; THAT IS, NO COMMAS, SYMBOLS OR LETTERS, EG, FOR \$10,000, ENTER 10000

\$ _____
.K Don't know
.R Refused

[Showcard 1Y]

1.146 Which of the reasons on this card best describes why you make short-term speculative investments? You can choose as many as you like. [Code or record all mentioned]

- 1 To win prizes/money
- 2 For excitement/or a challenge
- 3 To support worthy causes
- 4 Out of curiosity
- 5 To oblige or please other people
- 6 As a gift for another person
- 7 As an interest/or a hobby
- 8 To be with people/get out of the house
- 9 As entertainment
- 77 Other reasons **[Specify]:** _____

NOT ON SHOWCARD:

- .K Don't know
- .R Refused

If only 6 selected go to 1.150.

1.147 Thinking about making short-term speculative investments, in the last twelve months would you say you have...? [Read out all and code one only]

① TO WIN MONEY MEANS TO MAKE MONEY ON THEIR INVESTMENT

- 1 Won money overall
- 2 Broken even
- 3 Lost money overall

DO NOT READ OUT:

- .K Don't know
- .R Refused

1.148 Do you use any system or special skills to improve your chances of making money on short-term speculative investments? [Code one only]

- 1 Yes
- 5 No
- 98 Don't know/Don't know of any such system
- .R Refused

If 1 recorded in 1.148, go to 1.149.

Otherwise go to instruction prior to 1.150.

1.149 Could you please describe that to me? [Record verbatim]

-
- .R Refused

ASK ALL RESPONDENTS:

OTHER ONLINE GAMBLING

[Showcard 1Z]

1.150 Please look at Card 1Z. In the last 12 months, have you bet any money, bought any tickets or paid to do any of these activities online through an overseas website for money or prizes? Which of these have you done?

Do not include placing a bet through a NZ TAB account, buying a ticket through a NZ MyLotto account, spending money to download games onto your PC, purchasing game software, or doing any of the activities on the showcard for free. [Code all mentioned]

Also please do not include any online activities you have already talked about.

95 is a unique code.

- 1 Placed a bet on an event through an overseas website, for example, an election result or TV show
- 2 Played online casino games other than card games such as roulette, etc
- 3 Played Internet bingo.
- 4 Played skill games online such as chess, scrabble, mah-jong, bridge, backgammon, etc
- 5 Placed a bet on a virtual race or sports event
- 77 Participated in any other gambling or lottery activity (for example, online gaming machines or instant games) online through an overseas website for money [**Specify**]: _____
- 78
- 79
- 80
- 81

GO TO 1.151

95 None of the above → GO TO 1.154a

NOT ON SHOWCARD:
.K Don't know
.R Refused

[Showcard 1AA]

1.151 About how often do you do any of the activities on Card 1Z...? [Code one only]

Ⓢ IF MORE THAN ONE ACTIVITY MENTIONED IN 1.150 RECORD TOTAL FREQUENCY. IF UNSURE, RECORD THE MOST FREQUENT OPTION. FOR EXAMPLE, IF ONCE A WEEK (3) AND ONCE A YEAR (10) MENTIONED, CODE (3) – ONCE A WEEK

- 1 Four times a week or more
- 2 Two or three times a week
- 3 Once a week
- 4 Once every two weeks
- 5 Once every three weeks
- 6 Once a month
- 7 Once every two months
- 8 Once every three months
- 9 Once every six months
- 10 Once a year
- 11 Less frequently than once a year

NOT ON SHOWCARD:
.K Don't know
.R Refused

1.152 When you do any of the activities on Card 1Z about how much do you bet in a typical month?

- ① RECORD TO THE NEAREST DOLLAR, EG, \$60 = 60
- ① DO NOT RECORD CENTS, EG, \$2.50 = 3
- ① IF RESPONDENTS SAYS BETWEEN TWO AMOUNTS, IE, \$40 TO \$50 RECORD THE AVERAGE 45
- ① ENTER NUMBERS ONLY; THAT IS, NO COMMAS, SYMBOLS OR LETTERS, EG, FOR \$10,000, ENTER 10000

\$ _____

.K Don't know

.R Refused

[Showcard 1BB]

1.153 a. Which of the reasons on this card best describes why you do any of these activities...? You can choose as many as you like. [Code or record all mentioned]

- 1 To win prizes/money
- 2 For excitement/or a challenge
- 3 To support worthy causes
- 4 Out of curiosity
- 5 To oblige or please other people
- 6 As a gift for another person
- 7 As an interest/or a hobby
- 8 To be with people/get out of the house
- 9 As entertainment
- 77 Other reasons [Specify]: _____
- .K Don't know
- .R Refused

b. Thinking about when you do any of the activities on Card 1Z, in the last twelve months would you say you have...? [Read out all and code one only]

- 1 Won money overall
- 2 Broken even
- 3 Lost money overall

DO NOT READ OUT:
 .K Don't know
 .R Refused

1.154 a. Is there any other gambling activity that you have not mentioned that you have undertaken in the last 12 months for money or prizes (eg, participated in a casino evening for fundraising purposes)? [Code one only]

① DO NOT INCLUDE BONUS BONDS

If ① not circled in any of 1.02 and 1.03 and 95, .k or .r selected in 1.150 go to 1.158, otherwise go to instruction prior to 1.155.

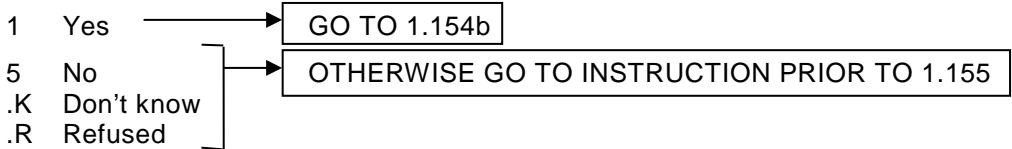

b. Please specify? [Record all mentioned]

① DO NOT INCLUDE BONUS BONDS (ALLOW UP TO 5 MENTIONS)

- a. _____
- b. _____
- c. _____
- d. _____
- e. _____

[Showcard 1AA]

c. About how often do you do any of these other gambling activities? [Code one only]
 ① IF MORE THAN ONE ACTIVITY MENTIONED IN 1.154b RECORD TOTAL FREQUENCY. IF UNSURE, RECORD THE MOST FREQUENT OPTION. FOR EXAMPLE, IF ONCE A WEEK (3) AND ONCE A YEAR (10) MENTIONED, CODE (3) – ONCE A WEEK

- 1 Four times a week or more
- 2 Two or three times a week
- 3 Once a week
- 4 Once every two weeks
- 5 Once every three weeks
- 6 Once a month
- 7 Once every two months
- 8 Once every three months
- 9 Once every six months
- 10 Once a year
- 11 Less frequently than once a year

NOT ON SHOWCARD:
 .K Don't know
 .R Refused

All people who answer YES to participating in ANY online gambling are routed to the following questions:

- 1. If 1-81 selected in 1.150 or if:
 - a. 1.143 = 1 or 3 and/or
 - b. 1.41 = 1-11 and/or
 - c. 1.49 = 1-11
 - d. 1.19 = 1-11
 ask 1.156.
 - 2. If 95, .K or .R selected in 1.150 but:
 - a. 1-11 coded in any of the following questions 1.04, 1.35, 1.63, 1.77, 1.81, 1.96, 1.100 or 1.144 (and 1.143 = 2) or
 - b. If 1.02d and/or 1.03c = 1
 - c. If 1.154a = 1
 then ask 1.155.
- If neither ① or ② apply go to 1.158.

1.155 Have you gambled online in the last 12 months (eg, via the internet through a PC, laptop, iPad, iPhone, or any other handheld device), or interactive TV for money or prizes? [Code one only]

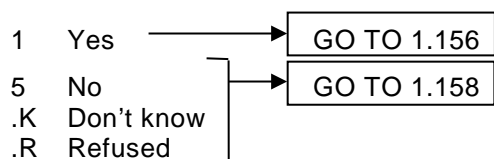

1.156 Which of the following reasons best describe why you participate in online gambling?
 ① READ OUT AND CODE OR RECORD ALL MENTIONED
 ① RESPONDENT PREVIOUSLY SAID YES TO ANY ACTIVITY IN 1.150 AND/OR PLAYED POKER ONLINE, AND/OR BOUGHT A LOTTO TICKET ONLINE AND/OR BOUGHT A KENO TICKET ONLINE AND/OR MADE A SPECULATIVE INVESTMENT ONLINE.

[Programmer: If only one option selected in 1.156, go to 1.158]

1.157 And which of these would be your MAIN reason for gambling online? [Code one only]**[Programmer: Insert reasons selected in 1.156.]**

	1.156 Reasons mentioned	1.157 Main reason
It's anonymous	1	1
Can do it from home	2	2
Can do it when it's most convenient to me	3	3
Bigger or better prizes or money	4	4
Easier to win/more chance of winning	5	5
More fun	6	6
Games not available in New Zealand	7	7
Other [Specify]: _____	77	77
	78	78
	79	79
	DO NOT READ OUT: .K Don't know .R Refused	.K .R

→ **GO TO 1.158**

PLAYING GAMBLING TYPE GAMES NOT FOR MONEY OR PRIZES

[Showcard 1CC]

1.158 Please look at Card 1CC. In the last 12 months, have you played any of the following NOT for money or prizes, eg, for points? Which of these have you done? [Multiple response allowed]

95 is a unique code.

- 1 Fantasy Football, Virtual Rugby, etc
- 2 Played Internet poker
- 3 Played other online casino games such as blackjack, roulette, etc
- 4 Played Internet bingo
- 5 Played skill games online such as chess, scrabble, mah-jong, bridge, backgammon, etc
- 77 Participated in any other gambling or lottery activity NOT for money or prizes

[Specify]: _____

95 None of the above

GO TO INSTRUCTION PRIOR TO 1.160

NOT ON SHOWCARD:

- .K Don't know
- .R Refused

[Showcard 1DD]

1.159a About how often do you participate in non-money based gambling activities? [Code one only]

- 1 Four times a week or more
- 2 Two or three times a week
- 3 Once a week
- 4 Once every two weeks
- 5 Once every three weeks
- 6 Once a month
- 7 Once every two months
- 8 Once every three months
- 9 Once every six months
- 10 Once a year
- 11 Less frequently than once a year

NOT ON SHOWCARD:

- .K Don't know
- .R Refused

[Showcard 1EE]

1.159b On an average day when you participate in non-money based gambling activities, how long do you participate for? [Code one only]

- 1 Up to 15 minutes
- 2 More than 15 minutes, and up to 30 minutes
- 3 More than 30 minutes, and up to one hour
- 4 More than one hour, and up to two hours
- 5 More than two hours, and up to three hours
- 6 More than three hours

DO NOT READ OUT:

- .K Don't know
- .R Refused

If 1 is not selected in any of 1.02, 1.03 and 1.154a, and 95 or .K or .R selected in 1.150, go to 2.01. Otherwise, go to 1.160.

GAMBLING PARTICIPATION

If 6 'as a gift for another person' is the only reason respondent gambles, that is only 6 is selected in: 1.37, 1.45, 1.53, 1.59 and/or 1.146 go to 2.01.

If only one activity selected in 1.02 and 1.03 and 1.150 and 1.154b overall, ask 1.160b.

Do not include 1.02e, 1.03a, 1.03b, 1.03d or 1.03h, if 6 'as a gift for another person' is the only reason respondent says they partake in that activity (1.37, 1.45, 1.53, 1.59 and 1.146).

- 1.160 a. Thinking about [INSERT ALL ACTIVITIES SELECTED IN 1.02, 1.03, 1.150 and 1.154b], please tell me which is the gambling activity that you MOST enjoyed in the last 12 months? [Code one only]
- b. Thinking about [INSERT SINGLE ACTIVITY SELECTED IN 1.02, 1.03, 1.150 or 1.154b], please tell me did you enjoy taking part in this activity, in the last 12 months? [Code one only] If only one activity overall.
- 1.161 a. And are there any of the following gambling activities that you particularly enjoyed? [Read out and code all mentioned]

If only one other activity ask 1.161b.

- b. And did you enjoy the following gambling activity? [Code one only]

Programmer: If 94, 95 or .K or .R is selected in 1.160 go to 1.163. Show all activities, excluding activity chosen in 1.160.

95 is a unique code.

		1.160 Most Preferred	1.161 Others particularly enjoyed
1	Lotteries Commission Lotto (this includes Strike, Powerball and Big Wednesday)	1	1
2	Lotteries Commission Keno	2	2
3	Lotteries Commission Bullseye	3	3
4	Instant Kiwi or other Scratch ticket	4	4
5	Housie (bingo) for money	5	5
6	Betting on horse or dog races (includes any bets made in New Zealand, overseas, or with an overseas betting organisation, whether at the track, a TAB outlet, a TAB in a pub or club, by telephone, online, or by interactive TV)	6	6
7	Betting on a sporting event, other than horse or dog races, (includes any bets made in New Zealand, overseas or with an overseas betting organisation, whether at a TAB outlet, a TAB in a pub or club, by telephone, online or by interactive TV)	7	7
8	Gaming machines or pokies, table games or any other games at an overseas casino	8	8
9	Gaming machines, or pokies, table games or any other games at one of the six casinos (Auckland, Hamilton, Christchurch, Dunedin, Queenstown)	9	9
10	Gaming machines or pokies in a pub (not a casino or club)	10	10
11	Gaming machines or pokies in a club (not in a casino or pub)	11	11
12	Card games played for money, but NOT at a Casino	12	12
13	Bets with friends or workmates on such things as the Super 15 Rugby, etc for money or prizes	13	13
14	Text (or mobile phone) games or competitions for money or prizes	14	14
15	Bought a ticket in an overseas raffle or lottery (includes tickets bought in an overseas shop, by telephone, through the post or online)	15	15
16	Bought a ticket in a NZ raffle or lottery (does not include Lotteries Commission games: Lotto; Strike; Powerball; Big Wednesday; Keno; Bullseye; or Instant Kiwi)	16	16
17	Short-term speculative investments like day trading in stocks and shares	17	17
18	Betting on an event through an overseas website, eg, an election result or TV show	18	18
19	Online casino games (excluding card games), such as roulette, etc	19	19
20	Internet bingo	20	20
21	Skill games online, ie, chess, scrabble, mah-jong, bridge, backgammon	21	21
22	Betting on a virtual race or sports event	22	22
77-81	Other [Specify]: _____ - Code separately	77	77
		DO NOT READ OUT: .K Don't know .R Refused 94 No preference/enjoy all equally 95 No/none ↓ GO TO 1.163	DO NOT READ OUT: 94 – No preference/enjoy them all equally 95 – No/none .K .R

1.162 When you played [INSERT most preferred activity selected in 1.160] over the past 12 months, did you mostly play ...? [Code one only]

- 1 Alone
- 2 With one person
- 3 With several/with a group
- .K Don't know
- .R Refused

1.163 Is there anything you think of, or do, to stop yourself from spending too much money and/or time on gambling? [Code one only]

- 1 Yes → GO TO 1.164
 - 5 No
 - .K Don't know
 - .R Refused
- } → GO TO 2.01

[Showcard 1FF]

1.164 From Card 1FF, can you tell me what you think of or do? [Code or record all mentioned]

[Showcard 1GG]

1.165 From Card 1GG, how effective (is that / are they) in stopping you from gambling too much? [Code one only, for each method mentioned in 1.164.]

Programmer: allow each code mentioned in 1.164 to be rated in 1.165

1.164 Method Mentioned		1.165 How Effective?
1	Setting a dollar figure before leaving home	1 Very effective 2 Effective 3 Neither effective nor ineffective 4 Ineffective 5 Very ineffective NOT ON SHOWCARD: .K Don't know .R Refused
2	Getting someone you trust to manage the money	1 Very effective 2 Effective 3 Neither effective nor ineffective 4 Ineffective 5 Very ineffective NOT ON SHOWCARD: .K Don't know .R Refused
3	Separating money for betting from other money, and stopping when it is used up	1 Very effective 2 Effective 3 Neither effective nor ineffective 4 Ineffective 5 Very ineffective NOT ON SHOWCARD: .K Don't know .R Refused
4	Leaving ATM and credit cards at home	1 Very effective 2 Effective 3 Neither effective nor ineffective 4 Ineffective 5 Very ineffective NOT ON SHOWCARD: .K Don't know .R Refused
5	Setting a time limit	1 Very effective 2 Effective 3 Neither effective nor ineffective 4 Ineffective 5 Very ineffective NOT ON SHOWCARD: .K Don't know .R Refused
6	Avoiding places that have betting or gambling as an attraction	1 Very effective 2 Effective 3 Neither effective nor ineffective 4 Ineffective 5 Very ineffective NOT ON SHOWCARD: .K Don't know .R Refused

1.164 Method Mentioned		1.165 How Effective?
77	Other [Specify]: _____	1 Very effective 2 Effective 3 Neither effective nor ineffective 4 Ineffective 5 Very ineffective NOT ON SHOWCARD: .K Don't know .R Refused
78		1 Very effective 2 Effective 3 Neither effective nor ineffective 4 Ineffective 5 Very ineffective NOT ON SHOWCARD: .K Don't know .R Refused
79		1 Very effective 2 Effective 3 Neither effective nor ineffective 4 Ineffective 5 Very ineffective NOT ON SHOWCARD: .K Don't know .R Refused
	.K Don't know .R Refused ↓ GO TO 2.01	

2. PAST GAMBLING AND RECENT GAMBLING BEHAVIOUR CHANGE

[Showcard 2A]

Please think about ALL the different types of activities on Showcard 2A, which we have just asked you about.

[Showcard 2B]

2.01 In the last 12 months, that is since {ADD DATE ONE YEAR AGO} has your overall involvement in these activities stayed the same, increased or decreased? [Code one only]
Please select your answer from Card 2B.

ⓐ If respondent says they **DO NOT** gamble/have not gambled in last 12 months, then select **CODE 3** – stayed the same.

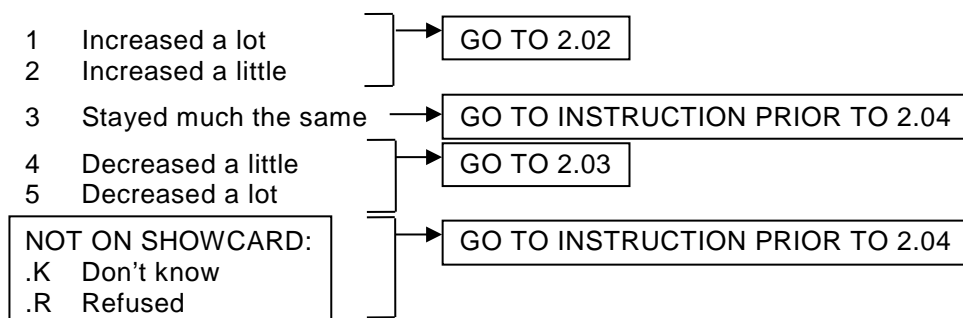

[Showcard 2C]

2.02 Looking at Card 2C, what were the main reasons for the increase in your gambling involvement? [Code or record all mentioned]

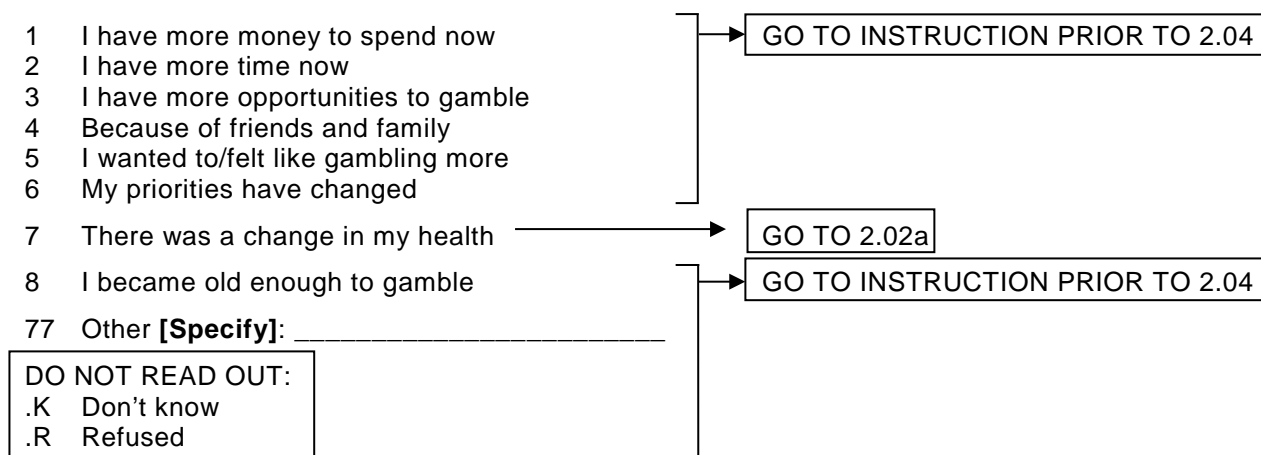

a. Did your health get better or worse? [Code one only]

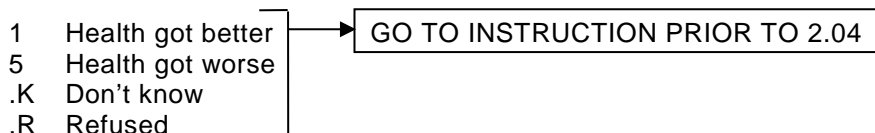

[Showcard 2D]

2.03 Looking at Card 2D, what were the main reasons for the decrease in your gambling involvement since this time last year? [Code or record all mentioned]

- 1 I have less money to spend now
- 2 I want to save money/spend money on other things
- 3 I have less time/ I'm too busy now
- 4 I have fewer opportunities to gamble
- 5 I have lost interest in the activities I used to do
- 6 My priorities have changed

GO TO INSTRUCTION
PRIOR TO 2.04

7 There was a change in my health

GO TO 2.03a

77 Other [Specify]: _____

GO TO INSTRUCTION
PRIOR TO 2.04

DO NOT READ OUT:

- .K Don't know
- .R Refused

a. Did your health get better or worse? [Code one only]

- 1 Health got better
- 5 Health got worse
- .K Don't know
- .R Refused

GO TO INSTRUCTION PRIOR TO 2.04

If 1 is not selected in any of 1.02, 1.03 and 1.154a and 95 or .K or .R selected in 1.150, ask 2.04. Otherwise, go to 3.01.

[Showcard 2E]

2.04 Thinking about all the activities mentioned on Showcard 2E, and any other form of gambling activity. Have you ever spent money on any of these things? [Code one only]

- 1 Yes
- 5 No

GO TO 2.06

- .K Don't know
- .R Refused

GO TO 3.01

[Showcard 2E]

2.05 From Card 2E, what activities were they? [Code or record all mentioned]

Ⓛ GOLDEN KIWI IS TO BE CODED AS 1

Ⓛ DO NOT INCLUDE BONUS BONDS

		2.05 Activities
1	Lotteries Commission Lotto (this includes Strike, Powerball and Big Wednesday)	1
2	Lotteries Commission Keno	2
3	Lotteries Commission Bullseye	3
4	Instant Kiwi or other Scratch ticket	4
5	Housie (bingo) for money	5
6	Betting on horse or dog races (INCLUDES any bets made in New Zealand, overseas, or with an overseas betting organisation, whether at the track, a TAB outlet, a TAB in a pub or club, by telephone, online, or by interactive TV. DO NOT include informal bets with friends/workmates on such things as NRL, Super 15 Rugby, Melbourne Cup)	6
7	Betting on a sporting event, other than horse or dog races, (INCLUDES any bets made in New Zealand, overseas or with an overseas betting organisation, whether at a TAB outlet, a TAB in a pub or club, by telephone, online or by interactive TV. DO NOT include informal bets with friends/workmates on such things as NRL, Super 15 Rugby, Melbourne Cup)	7
8	Gaming machines or pokies, table games or any other games at an overseas casino	8
9	Gaming machines or pokies, table games, or any other games, at one of the six casinos (Auckland, Hamilton, Christchurch, Dunedin, Queenstown)	9
10	Gaming machines or pokies in a pub (not a casino or club)	10
11	Gaming machines or pokies in a club (not in a casino or pub)	11
12	Card games played for money, but NOT at a Casino	12
13	Bets with friends or workmates on such things as the Super 15 Rugby, etc for money or prizes	13
14	Text (mobile phone) games or competitions for money or prizes	14
15	Bought a ticket in an overseas raffle or lottery (includes tickets bought in an overseas shop, by telephone, through the post or online)	15
16	Bought a ticket in a NZ raffle or lottery (this includes school, work, church raffles, etc) (Does not include Lotteries Commission games: Lotto; Strike; Powerball; Big Wednesday; Keno; Bullseye; or Instant Kiwi)	16
17	Short-term speculative investments like day trading in stocks and shares	17
18	Betting on an event through an overseas website, eg, an election result or TV show	18
19	Online casino games (excluding card games), such as roulette, etc	19
20	Internet bingo	20
21	Skill games online, ie, chess, scrabble, mah-jong, bridge, backgammon	21
22	Betting on a virtual race or sports event	22
77	Other (do not include Bonus Bonds) [Specify]: _____	77
78		78
79		79
80		80
81		81
		.K Don't know .R Refused

GO TO 3.01

If 5 in 2.04, ask 2.06.

2.06 Why have you not gambled? [Record verbatim]

.K Don't know
.R Refused

GO TO 3.36

3. PROBLEM GAMBLING

PGSI

The next series of questions relate to gambling activity in the last 12 months.

If 1 is not selected in any of 1.02 and 1.03 and 1.154a and 95 or .K or .R selected in 1.150, and if 5 selected in 2.04, go to 3.36, otherwise ask 3.01.

FOR THE NEXT SERIES OF QUESTIONS PLEASE REFER TO CARD 3A.

[Showcard 3A]

3.01 Thinking about the past 12 months, how often have you bet more than you could really afford to lose? Would you say never, sometimes, most of the time or almost always? [Code one only]

- 1 Never
- 2 Sometimes
- 3 Most of the time
- 4 Almost always

NOT ON SHOWCARD: .K Don't know .R Refused

[Showcard 3A]

3.02 Thinking about the past 12 months, how often have you needed to gamble with larger amounts of money to get the same feeling of excitement? [Code one only]

- 1 Never
- 2 Sometimes
- 3 Most of the time
- 4 Almost always

NOT ON SHOWCARD: .K Don't know .R Refused

[Showcard 3A]

3.03 Thinking about the past 12 months, how often have you gone back another day to try to win back the money you lost? [Code one only]

- 1 Never
- 2 Sometimes
- 3 Most of the time
- 4 Almost always

NOT ON SHOWCARD: .K Don't know .R Refused

[Showcard 3A]

3.04 Thinking about the past 12 months, how often have you borrowed money or sold anything to get money to gamble? [Code one only]

- 1 Never
- 2 Sometimes
- 3 Most of the time
- 4 Almost always

NOT ON SHOWCARD: .K Don't know .R Refused

[Showcard 3A]

3.05 Thinking about the past 12 months, how often have you felt that you might have a problem with gambling? [Code one only]

- 1 Never
- 2 Sometimes
- 3 Most of the time
- 4 Almost always

NOT ON SHOWCARD:

- .K Don't know
- .R Refused

[Showcard 3A]

3.06 Thinking about the past 12 months, how often has your gambling caused you any health problems, including stress or anxiety? [Code one only]

- 1 Never
- 2 Sometimes
- 4 Most of the time
- 5 Almost always

NOT ON SHOWCARD:

- .K Don't know
- .R Refused

[Showcard 3A]

3.07 Thinking about the past 12 months, how often have people criticised your betting or told you that you had a gambling problem, regardless of whether or not you thought it was true? [Code one only]

- 1 Never
- 2 Sometimes
- 3 Most of the time
- 4 Almost always

NOT ON SHOWCARD:

- .K Don't know
- .R Refused

[Showcard 3A]

3.08 Thinking about the past 12 months, how often has your gambling caused any financial problems for you or your household? [Code one only]

- 1 Never
- 2 Sometimes
- 3 Most of the time
- 4 Almost always

NOT ON SHOWCARD:

- .K Don't know
- .R Refused

[Showcard 3A]

3.09 a. Thinking about the past 12 months, how often have you felt guilty about the way you gamble, or what happens when you gamble? [Code one only]

- 1 Never
- 2 Sometimes
- 3 Most of the time
- 4 Almost always

NOT ON SHOWCARD:

- .K Don't know
- .R Refused

[Showcard 3B]

b. Referring to Card 3B, in the past 12 months, have you gambled for money at your workplace/place of study instead of doing your job/studies? [Code one only]

- 1 Always
- 2 Often
- 3 Occasionally
- 4 Rarely
- 5 Never/almost never
- 6 Not applicable (don't work or study)

NOT ON SHOWCARD:

- .K Don't know
- .R Refused

3.10 I am now going to read out the following statement and ask you to say to what extent you agree or disagree with it. Please answer using a scale of 1 to 7, where 1 is "strongly disagree" and 7 is "strongly agree". [Code one only]

① If asked code 4 is neither agree nor disagree

I see myself as a gambler

- 1 Strongly disagree
- 2
- 3
- 4
- 5
- 6
- 7 Strongly agree
- .K Don't know
- .R Refused

HELP SEEKING

Now I'd like to explore the way gambling has influenced your life.

TRIED TO GET HELP: IN THE PAST 12 MONTHS

3.20 a. Have you tried to get help to reduce or stop gambling in the past 12 months, whether informally from a friend or more formally from a health professional? [Code one only]

① This includes accessing help via websites or through self-help publications.

1 Yes → GO TO 3.21

5 No
.K Don't know
.R Refused } → GO TO INSTRUCTION PRIOR TO 3.26

3.21 Where did you go for help? [Record verbatim]

.K Don't know
.R Refused

① for each mentioned in 3.21 ask 3.22 and 3.23.

3.22 Who mainly referred you to the help? [Record verbatim]

.K Don't know
.R Refused

3.23 What type of help did you get? [Record verbatim]

1. Record each type of help separately.
2. Press xx if no other help mentioned.

.K Don't know
.R Refused

[Showcard 3C]

3.24 From Card 3C, how effective was this help overall? [Code one only]

- 1 Very helpful
- 2 Helpful
- 3 Neither helpful nor unhelpful
- 4 Unhelpful
- 5 Very unhelpful

NOT ON SHOWCARD:
.K Don't know
.R Refused

① If only one mentioned in 3.23 or if .K, .R in 3.23 go to instruction prior to 3.26.

3.25 a. Was there any one type of help that was particularly helpful for you? [Code one only]

1 Yes → GO TO 3.25b

5 No
.K Don't know
.R Refused } → GO TO INSTRUCTION PRIOR TO 3.26

b. What help was that? [Record verbatim]

.R Refused

If 2, 3, 4 selected in any of 3.01-3.09a ask 3.26, otherwise go to 3.36.

FOR THE NEXT SERIES OF QUESTIONS PLEASE REFER TO CARD 3D.

The following questions are designed to identify how you personally feel about your gambling right now.

[Showcard 3D]

How much do you agree or disagree with the following?

3.26 I enjoy my gambling, but sometimes I gamble too much [Code one only]

- 1 Strongly disagree
- 2 Disagree
- 3 Neither agree nor disagree
- 4 Agree
- 5 Strongly agree

NOT ON SHOWCARD:
.K Don't know
.R Refused

[Showcard 3D]

3.27 Sometimes I think I should cut down on my gambling [Code one only]

- 1 Strongly disagree
- 2 Disagree
- 3 Neither agree nor disagree
- 4 Agree
- 5 Strongly agree

NOT ON SHOWCARD:
.K Don't know
.R Refused

[Showcard 3D]

3.28 It's a waste of time thinking about my gambling [Code one only]

- 1 Strongly disagree
- 2 Disagree
- 3 Neither agree nor disagree
- 4 Agree
- 5 Strongly agree

NOT ON SHOWCARD:
.K Don't know
.R Refused

[Showcard 3D]

3.29 I have just recently changed my gambling habits [Code one only]

- 1 Strongly disagree
- 2 Disagree
- 3 Neither agree nor disagree
- 4 Agree
- 5 Strongly agree

NOT ON SHOWCARD:

- .K Don't know
- .R Refused

[Showcard 3D]

3.30 Anyone can talk about wanting to do something about gambling but I am actually doing something about it [Code one only]

- 1 Strongly disagree
- 2 Disagree
- 3 Neither agree nor disagree
- 4 Agree
- 5 Strongly agree

NOT ON SHOWCARD:

- .K Don't know
- .R Refused

[Showcard 3D]

3.31 My gambling is a problem sometimes [Code one only]

- 1 Strongly disagree
- 2 Disagree
- 3 Neither agree nor disagree
- 4 Agree
- 5 Strongly agree

NOT ON SHOWCARD:

- .K Don't know
- .R Refused

[Showcard 3D]

3.32 There is no need for me to think about changing my gambling [Code one only]

- 1 Strongly disagree
- 2 Disagree
- 3 Neither agree nor disagree
- 4 Agree
- 5 Strongly agree

NOT ON SHOWCARD:

- .K Don't know
- .R Refused

[Showcard 3D]

3.33 I am actually changing my gambling habits right now [Code one only]

- 1 Strongly disagree
- 2 Disagree
- 3 Neither agree nor disagree
- 4 Agree
- 5 Strongly agree

NOT ON SHOWCARD:

- .K Don't know
- .R Refused

[Showcard 3D]

3.34 Gambling less would be pointless for me [Code one only]

- 1 Strongly disagree
- 2 Disagree
- 3 Neither agree nor disagree
- 4 Agree
- 5 Strongly agree

NOT ON SHOWCARD:

- .K Don't know
- .R Refused

GAMBLING IN HOUSEHOLDS

3.36 Excluding yourself, how much do people in your current household gamble? [Read out and code one only]

- 1 Not at all
- 2 A little
- 3 A moderate amount
- 4 A lot
- 5 Not applicable/live alone

DO NOT READ OUT:

- .K Don't know
- .R Refused

3.40 Now I am going to read you a couple of statements. Have any of these ever happened in your wider family or household, whether or not you were part of it? Some argument about time or money spent on betting or gambling... [Code one only]

- 1 Yes → GO TO 3.41
- 5 No } → GO TO 3.43
- .K Don't know }
- .R Refused }

3.41 Was this about ... [Read out and circle one only]

- 1 Your gambling
- 2 Someone else's gambling
- 3 Both

DO NOT READ OUT:

- .K Don't know
- .R Refused

3.42 And has this happened in the last 12 months? [Code one only]

- 1 Yes
- 5 No
- .K Don't know
- .R Refused

3.43 Now the second statement. Has this ever happened in your wider family or household, whether or not you were part of it? Someone had to go without something they needed, or some bills weren't paid, because too much was spent on gambling by another person... [Code one only]

- 1 Yes → GO TO 3.44
- 5 No } → GO TO 4.01
- .K Don't know }
- .R Refused }

3.44 Was this about ... [Read out and circle one only]

- 1 Your gambling
- 2 Someone else's gambling
- 3 Both

DO NOT READ OUT:

- .K Don't know
- .R Refused

3.45 And has this happened in the last 12 months? [Code one only]

- 1 Yes
- 5 No
- .K Don't know
- .R Refused

4. LIFE EVENTS AND ONGOING HASSLES

Now I'd like you to think about things that happened in your life during the past 12 months.

[Showcard 4A]

4.01 Which of the following life events shown on Card 4A did you experience in the past 12 months?
[Code all that apply]

95 is a unique code

4.01 Life Events Experienced	
1	Death of someone close to you
2	Divorce / Separation
3	Legal difficulties
4	Major injury or illness to either yourself or someone close to you
5	Marriage or finding a relationship partner
6	Troubles with your work, boss or superiors
7	Retirement
8	Pregnancy or new family additions
9	Major change to your financial situation
10	Taking on a mortgage, loan or making a big purchase
11	Increase in the number of arguments with someone you are close to
12	Moving house
13	Moving to new town/city
14	Major change in living or work conditions (eg renovations, new job)
15	Earthquake/natural disaster
77	Other significant life events [SPECIFY]: _____
78	
79	
80	
81	
95	None/no significant life events → GO TO 5.01
.K .R	Don't know } → GO TO 4.03a SUBJECT TO ROUTING INSTRUCTION AFTER 4.02b Refused }

4.02 a. Did any of these life events have a positive effect? [Code one only]

1 Yes → GO TO 4.02b

5 No } → IF 1 NOT SELECTED IN ANY OF 1.02, 1.03 AND 1.154a AND 95 OR .K OR .R
.K SELECTED IN 1.150 GO TO 5.01, OTHERWISE GO TO INSTRUCTION
.R PRIOR TO 4.03a

If only one life event mentioned in 4.01 ask 4.02ai.

ai. Did this life event have a positive effect? [Code one only]

1 Yes } → IF 1 NOT SELECTED IN ANY OF 1.02, 1.03 AND 1.154a AND 95 OR .K OR .R
5 No } SELECTED IN 1.150 GO TO 5.01, OTHERWISE GO TO 4.03a
.K
.R

Programmer: Insert life events mentioned in 4.01.

If only one life event mentioned in 4.01 go to 4.03b. Activity to be automatically entered in 4.02b.

b. Which life events were these? [Code all mentioned]

4.02b Life Events	
1	Death of someone close to you
2	Divorce / Separation
3	Legal difficulties
4	Major injury or illness to either yourself or someone close to you
5	Marriage or finding a relationship partner
6	Troubles with your work, boss or superiors
7	Retirement
8	Pregnancy or new family additions
9	Major change to your financial situation
10	Taking on a mortgage, loan or making a big purchase
11	Increase in the number of arguments with someone you are close to
12	Moving house
13	Moving to new town/city
14	Major change in living or work conditions (eg renovations, new job)
15	Earthquake/natural disaster
77	Other significant life events [SPECIFY]: _____
78	
79	
80	
81	

If 1 not in any of 1.02, 1.03 and 1.154a and 95 or .K or .R selected in 1.150. Go to 5.01.

If more than one selected in 4.01, ask 4.03a:

4.03 a. Did any particular life event trigger an increase in your gambling in the past 12 months, even if only temporarily? [Code one only]

If 4.01 = .K or R then skip to 4.05a.

If only one selected in 4.01, ask 4.03b:

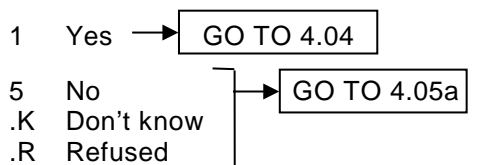

b. Did this particular life event trigger an increase in your gambling in the past 12 months, even if only temporarily? [Code one only]

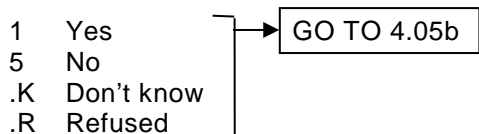

Programmer: Highlight all those selected in 4.01.

**4.04 Which life event caused an increase in your gambling? [Read out and code one only]
 ① IF MORE THAN ONE, ASK "WHICH EVENT WAS THE SINGLE BIGGEST TRIGGER?"**

- 1 Death of someone close to you
- 2 Divorce / Separation
- 3 Legal difficulties
- 4 Major injury or illness to either yourself or someone close to you
- 5 Marriage or finding a relationship partner
- 6 Troubles with your work, boss or superiors
- 7 Retirement
- 8 Pregnancy or new family additions
- 9 Major change to your financial situation
- 10 Taking on a mortgage, loan or making a big purchase
- 11 Increase in the number of arguments with someone you are close to
- 12 Moving house
- 13 Moving to new town/city
- 14 Major change in living or work conditions (eg renovations, new job)
- 15 Earthquake/natural disaster
- 77 Other significant life events [SPECIFY]: _____
- 78 _____
- 79 _____
- 80 _____
- 81 _____

DO NOT READ OUT:
 .K Don't know
 .R Refused

If more than one selected in 4.01, ask 4.05a:

4.05 a. Did any particular life event trigger a decrease in your gambling in the past 12 months, even if only temporarily? [Code one only]

- 1 Yes → GO TO 4.06
- 5 No } → GO TO 5.01
- .K Don't know }
- .R Refused }

If 4.01 = .K or .R then skip to 5.01.

If only one selected in 4.01, ask 4.05b:

b. Did this particular life event trigger a decrease in your gambling in the past 12 months, even if only temporarily? [Code one only]

- 1 Yes } → GO TO 5.01
- 5 No }
- .K Don't know }
- .R Refused }

Programmer: Highlight all those selected in 4.01.

**4.06 Which life event caused a decrease in your gambling? [Read out and code one only]
Ⓢ IF MORE THAN ONE, ASK "WHICH EVENT WAS THE SINGLE BIGGEST TRIGGER?"**

- 1 Death of someone close to you
- 2 Divorce / Separation
- 3 Legal difficulties
- 4 Major injury or illness to either yourself or someone close to you
- 5 Marriage or finding a relationship partner
- 6 Troubles with your work, boss or superiors
- 7 Retirement
- 8 Pregnancy or new family additions
- 9 Major change to your financial situation
- 10 Taking on a mortgage, loan or making a big purchase
- 11 Increase in the number of arguments with someone you are close to
- 12 Moving house
- 13 Moving to new town/city
- 14 Major change in living or work conditions (eg renovations, new job)
- 15 Earthquake/natural disaster

77 Other significant life events **[SPECIFY]:** _____
78 _____
79 _____
80 _____
81 _____

DO NOT READ OUT: .K Don't know .R Refused

5. GAMBLING IN NEW ZEALAND

Now we have some general questions about gambling in New Zealand.

[Showcard 5A]

5.01 Looking at Card 5A, I would like you to tell me for each of these things, whether you are generally in favour or generally not in favour of gambling activities being run for these purposes.
[Read out all and code one for each]

	Generally in favour	Generally not in favour	DO NOT READ OUT:	
			Don't know	Refused
a. Fundraising for worthy causes	1	5	.K	.R
b. A means of raising Government revenue (ie through government receiving the profits from gambling)	1	5	.K	.R
c. Sales promotion (eg prize competitions to promote products)	1	5	.K	.R
d. Business enterprise (ie for commercial profit, eg casinos)	1	5	.K	.R
e. Profit sharing between a promoter and a worthy cause	1	5	.K	.R
① IF ASKED: Any profit (that is, income over and above expenditure) is shared, although this does not necessarily mean that the sharing of profit is equal.				

5.02 Some of the profits from gambling in New Zealand are given to sport, charities and community. Thinking about how the money is given out at present, are you ...? [Read out and code one only]

- 1 Happy with it → GO TO 5.04
- 2 Largely happy, but with some doubts → GO TO 5.03
- 3 Not happy with it → GO TO 5.03
- 4 Or, no impression either way → GO TO 5.04
- .K Don't know
- .R Refused

5.03 Why do you say that? [Record verbatim and probe fully]

-
- .K Don't know
 - .R Refused

NEW ZEALAND GAMBLING INDUSTRY (ALL RESPONDENTS)

Now we have some questions about the nature of the gambling industry in New Zealand.

5.04 Think about all the places where people can go to gamble in the area you live in. Do you think there are ...? [Read out all and code one only]

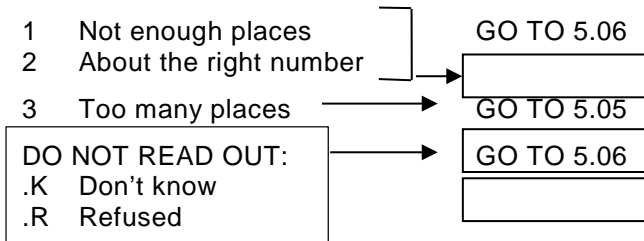

5.05 What types of places and venues are there too many of? [Code all mentioned]

7 is a unique code – except when code 77 is used

- 1 Lotto/ Keno/Instant Kiwi outlets
- 2 Housie/bingo venues
- 3 TABs
- 4 Gaming machine (pokie) venues ie, pubs/clubs
- 5 Casinos
- 7 All gambling venues/gambling venues in general
- 77 Other [**SPECIFY**]: _____
- .K Don't know
- .R Refused

[Showcard 5B]

5.06 Please look at Card 5B closely and tell me any of these activities that you think are socially undesirable. [Code or record all mentioned]

Ⓢ IF NECESSARY: 'By socially undesirable I mean likely to cause harm to people in general'

95 is a unique code

- 1 Lotto
- 2 Instant Kiwi
- 3 Daily Keno
- 4 Raffles
- 5 Housie/bingo
- 6 Betting on horse and dog racing
- 7 Sports betting
- 8 Table games at casinos
- 9 Gaming machines or pokies at a casino
- 10 Gaming machines or pokies at a pub
- 11 Gaming machines or pokies at a club
- 12 Text (mobile phone) games or competitions
- 13 Online gambling
- 77 Other **[SPECIFY]:** _____
- 95 None of these

NOT ON SHOWCARD:

- 96 All of them
- .K Don't know
- .R Refused

[Showcard 5C]

5.07 From Card 5C, do you agree strongly, agree, disagree, or disagree strongly that...?

[Read out each statement and code one for each]

	Agree strongly	Agree	Disagree	Disagree strongly	NOT ON SHOWCARD:		
					Don't know	Refused	Neither agree nor disagree
a. There is a growing problem in New Zealand with people being heavily involved in gambling	1	2	3	4	.K	.R	5
b. People who provide gambling activities should be required to do more about their customers gambling to excess	1	2	3	4	.K	.R	5
c. Government should do more about people gambling to excess	1	2	3	4	.K	.R	5

6. MENTAL HEALTH

KESSLER

FOR THE NEXT SERIES OF QUESTIONS PLEASE REFER TO CARD 6A.

The following questions ask about how you have been feeling during the past four weeks.

[Showcard 6A]

6.01 In the past four weeks, about how often did you feel tired out for no good reason? [Code one only]

- 1 None of the time
- 2 A little of the time
- 3 Some of the time
- 4 Most of the time
- 5 All of the time

NOT ON SHOWCARD:
.K Don't know
.R Refused

[Showcard 6A]

6.02 In the past four weeks, about how often did you feel nervous? [Code one only]

- 1 None of the time → GO TO 6.04
- 2 A little of the time
- 3 Some of the time
- 4 Most of the time
- 5 All of the time

NOT ON SHOWCARD: → GO TO 6.04
.K Don't know
.R Refused

[Showcard 6A]

6.03 In the past four weeks, about how often did you feel so nervous that nothing could calm you down? [Code one only]

- 1 None of the time
- 2 A little of the time
- 3 Some of the time
- 4 Most of the time
- 5 All of the time

NOT ON SHOWCARD:
.K Don't know
.R Refused

[Showcard 6A]

6.04 In the past four weeks, about how often did you feel hopeless? [Code one only]

- 1 None of the time
- 2 A little of the time
- 3 Some of the time
- 4 Most of the time
- 5 All of the time

NOT ON SHOWCARD:
.K Don't know
.R Refused

[Showcard 6A]

6.05 In the past four weeks, about how often did you feel restless or fidgety? [Code one only]

1 None of the time → GO TO 6.07

2 A little of the time
3 Some of the time } GO TO 6.06
4 Most of the time
5 All of the time }

NOT ON SHOWCARD: → GO TO 6.07

.K Don't know
.R Refused

[Showcard 6A]

6.06 In the past four weeks, about how often did you feel so restless you could not sit still? [Code one only]

- 1 None of the time
- 2 A little of the time
- 3 Some of the time
- 4 Most of the time
- 5 All of the time

NOT ON SHOWCARD:

.K Don't know
.R Refused

[Showcard 6A]

6.07 In the past four weeks, about how often did you feel depressed? [Code one only]

- 1 None of the time
- 2 A little of the time
- 3 Some of the time
- 4 Most of the time
- 5 All of the time

NOT ON SHOWCARD:

.K Don't know
.R Refused

[Showcard 6A]

6.08 In the past four weeks, about how often did you feel that everything was an effort? [Code one only]

- 1 None of the time
- 2 A little of the time
- 3 Some of the time
- 4 Most of the time
- 5 All of the time

NOT ON SHOWCARD:

.K Don't know
.R Refused

[Showcard 6A]

6.09 In the past four weeks, about how often did you feel so sad that nothing could cheer you up? [Code one only]

- 1 None of the time
- 2 A little of the time
- 3 Some of the time
- 4 Most of the time
- 5 All of the time

NOT ON SHOWCARD:

- .K Don't know
- .R Refused

[Showcard 6A]

6.10 In the past four weeks, about how often did you feel worthless? [Code one only]

- 1 None of the time
- 2 A little of the time
- 3 Some of the time
- 4 Most of the time
- 5 All of the time

NOT ON SHOWCARD:

- .K Don't know
- .R Refused

QUALITY OF LIFE (WHOQOL-8)

[Showcard 6B]

This next set of questions asks how you feel about your quality of life, health or other areas of your life. We ask that you think about your life in the past 2 weeks. Please refer to Card 6B.

Ⓞ IF REQUIRED: 'We realise the last two weeks might not be typical of your overall life in general, however, this is the time frame we are interested in for these questions'

6.11 How satisfied are you with your health? [Code one only]

- 1 Very dissatisfied
- 2 Dissatisfied
- 3 Neither dissatisfied nor satisfied
- 4 Satisfied
- 5 Very satisfied

NOT ON SHOWCARD:

- .K Don't know
- .R Refused

[Showcard 6B]

6.12 How satisfied are you with your ability to perform your daily activities? [Code one only]

- 1 Very dissatisfied
- 2 Dissatisfied
- 3 Neither dissatisfied nor satisfied
- 4 Satisfied
- 5 Very satisfied

NOT ON SHOWCARD:

- .K Don't know
- .R Refused

[Showcard 6B]

6.13 How satisfied are you with yourself? [Code one only]

- 1 Very dissatisfied
- 2 Dissatisfied
- 3 Neither dissatisfied nor satisfied
- 4 Satisfied
- 5 Very satisfied

NOT ON SHOWCARD:

- .K Don't know
- .R Refused

[Showcard 6B]

6.14 How satisfied are you with your personal relationships? [Code one only]

- 1 Very dissatisfied
- 2 Dissatisfied
- 3 Neither dissatisfied nor satisfied
- 4 Satisfied
- 5 Very satisfied

NOT ON SHOWCARD:

- .K Don't know
- .R Refused

[Showcard 6B]

6.15 How satisfied are you with the conditions of your living place? [Code one only]

- 1 Very dissatisfied
- 2 Dissatisfied
- 3 Neither dissatisfied nor satisfied
- 4 Satisfied
- 5 Very satisfied

NOT ON SHOWCARD:

- .K Don't know
- .R Refused

[Showcard 6C]

6.16 Now looking at Card 6C, do you have enough energy for everyday life? [Code one only]

- 1 Not at all
- 2 A little
- 3 Moderately
- 4 Mostly
- 5 Completely

NOT ON SHOWCARD:

- .K Don't know
- .R Refused

[Showcard 6C]

6.17 Have you enough money to meet your needs? [Code one only]

- 1 Not at all
- 2 A little
- 3 Moderately
- 4 Mostly
- 5 Completely

NOT ON SHOWCARD:

- .K Don't know
- .R Refused

6.18 How would you rate your quality of life? Would you say it is... [Read out and code one only]

- 1 Very poor
- 2 Poor
- 3 Neither poor nor good
- 4 Good
- 5 Very good

DO NOT READ OUT:

- .K Don't know
- .R Refused

7. ALCOHOL USE/MISUSE

I would now like to ask you some questions about your alcohol consumption.

7.01 Have you had a drink containing alcohol in the last year? [Code one only]

1 Yes

5 No

.K Don't know

.R Refused

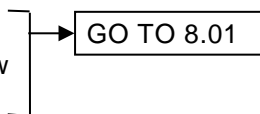

**7.02 Think back to when you first started drinking alcohol, how old were you then? [Record Years]
⓪ ENTER ANSWER IN YEARS. IF RESPONDENT DOESN'T KNOW EXACTLY, GET THEIR BEST ESTIMATE.**

--	--	--	--

.K Don't know

.R Refused

7.03 In the last 12 months, have you ever made a serious attempt to reduce how much you drink? [Code one only]

1 Yes

5 No

.K Don't know

.R Refused

ALCOHOL USE (AUDIT-C)

7.04 How often do you have a drink containing alcohol? [Code one only]

① DON'T PROMPT ANSWER. WAIT AND CODE.

① IF RESPONDENT SAYS THAT THEY ARE NOT CURRENTLY DRINKING ASK THEM TO THINK ABOUT THE PERIOD OVER THE LAST 12 MONTHS IN WHICH THEY WERE DRINKING ALCOHOL, AND ANSWER THE QUESTION FOR THAT PERIOD.

- 1 Monthly or less
- 5 Up to 4 times a month
- 6 Up to 3 times a week
- 4 4 or more times a week

DO NOT READ OUT:

- .K Don't know
- .R Refused

7.05 How many drinks containing alcohol do you have on a typical day when you are drinking? [Code one only]

① TAKE AVERAGE AND ROUND TO NEAREST WHOLE NUMBER IF NECESSARY, EG, IF RESPONDENTS SAYS 4 OR 5, AVERAGE IS 4.5, ROUND TO NEAREST WHOLE NUMBER = 5, THAT IS CODE 5.

① IF RESPONDENT SAYS THAT THEY ARE NOT CURRENTLY DRINKING ASK THEM TO THINK ABOUT THE PERIOD OVER THE LAST 12 MONTHS IN WHICH THEY WERE DRINKING ALCOHOL, AND ANSWER THE QUESTION FOR THAT PERIOD.

- 1 1 or 2
- 3 3 or 4
- 5 5 or 6
- 7 7 to 9
- 10 10 or more
- .K Don't know
- .R Refused

[Showcard 7A]

7.06 Looking at Card 7A, how often do you have six or more drinks on one occasion? [Code one only]

① IF RESPONDENT SAYS THAT THEY ARE NOT CURRENTLY DRINKING ASK THEM TO THINK ABOUT THE PERIOD OVER THE LAST 12 MONTHS IN WHICH THEY WERE DRINKING ALCOHOL, AND ANSWER THE QUESTION FOR THAT PERIOD.

- 1 Never
- 2 Less than monthly
- 3 Monthly
- 4 Weekly
- 5 Daily or almost daily

NOT ON SHOWCARD:

- .K Don't know
- .R Refused

7.07 Have you ever tried to get help to reduce or stop drinking, whether informally from a friend, or more formally, from a health professional? [Code one only]

- 1 Yes
- 5 No
- .K Don't know
- .R Refused

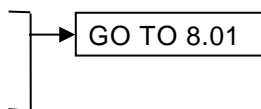

7.08 Have you done this in the past 12 months? [Code one only]

- 1 Yes
- 5 No
- .K Don't know
- .R Refused

8. SUBSTANCE USE/MISUSE

TOBACCO

Now some questions on smoking cigarettes or tobacco.

8.01 Have you ever smoked cigarettes or tobacco at all, even just a few puffs. Please include pipes and cigars?” [Code one only]

① If asked, this does not include marijuana/cannabis

- 1 Yes
 - 5 No
 - .K Don't know
 - .R Refused
- GO TO 8.11

8.02 Have you ever smoked a total of more than 100 cigarettes in your whole life? [Code one only]

- 1 Yes
 - 5 No
 - .K Don't know
 - .R Refused
- GO TO 8.11

8.03 Did you ever smoke DAILY for a period of time? [Code one only]

① IF RESPONDENT ASKS, “PERIOD OF TIME” MEANS FOR AT LEAST A WEEK.

- 1 Yes
 - 5 No
 - .K Don't know
 - .R Refused
- GO TO 8.05

8.04 At what age did you START smoking DAILY? [Record] _____

① ENTER ANSWER IN YEARS. IF RESPONDENT DOESN'T KNOW EXACTLY, GET THEIR BEST ESTIMATE.

- .K Don't know
- .R Refused

8.05 How often do you now smoke? [Code one only]

① READ OUT ANSWER OPTIONS. IF MORE THAN ONE FREQUENCY GIVEN, CODE THE HIGHEST ONE.

- 1 You do not smoke now → GO TO 8.07
- 2 At least once a day → GO TO 8.06
- 3 At least once a week
- 4 At least once a month
- 5 Less often than once a month

- DO NOT READ OUT:
- .K Don't know
 - .R Refused
- GO TO 8.06

8.06 On average, how many cigarettes do you smoke a day? [Circle one]
Ⓢ IF RESPONDENT IS UNABLE TO SUGGEST AN AVERAGE, ASK FOR THE TYPICAL NUMBER OF CIGARETTES SMOKED IN A WEEK AND DIVIDE BY 7
Ⓢ ROUND ANSWER TO NEAREST NUMBER IF NECESSARY EG, 2.5 CIGARETTES A DAY SHOULD BE ENTERED AS 3 THAT IS CODE 2

- 1 Less than 1 per day
 - 2 1-5 per day
 - 3 6-10 per day
 - 4 11-15 per day
 - 5 16-20 per day
 - 6 21-25 per day
 - 7 26-30 per day
 - 8 31 or more a day
 - .K Don't know/unsure
 - .R Refused
- GO TO 8.08

8.07 How long ago did you stop smoking? [Code one only]

- 1 Within the last month
 - 2 1 month to 3 months ago
 - 3 4 months to 6 months ago
 - 4 7 to 12 months ago
 - 5 1 to 2 years ago
 - 6 2 to 5 years ago
 - 7 Longer than 5 years ago
 - .K Don't know
 - .R Refused
- GO TO 8.11

8.08 In the last 12 months, how many serious attempts to stop smoking did you make that lasted 24 hours or longer? Please include any attempt that you are currently making.

[Record] _____
Ⓢ IF NONE RECORD 0.

- .K Don't know
- .R Refused

8.09 Have you ever tried to get help to stop smoking, whether informally from a friend, or more formally, from a health professional? [Code one only]

- 1 Yes
 - 5 No
 - .K Don't know
 - .R Refused
- GO TO 8.11

8.10 Have you done this in the past 12 months? [Code one only]

- 1 Yes
- 5 No
- .K Don't know
- .R Refused

OTHER DRUGS

The next questions are about other drugs.

[Showcard 8A]

8.11 From Card 8A, which of the following drugs have you used in the last 12 months for recreational purposes or to get high? Please just read out the number next to the words.

[Code all mentioned]

① PROMPT: any others?

- 1 Cannabis (marijuana, hash, hash oil)
- 2 Ecstasy
- 3 Amphetamines, for example, 'P' ('pure' methamphetamine), ice (crystal methamphetamine), speed
- 4 Legal party pills
- 5 Stimulants, for example Ritalin®
- 6 Painkillers, for example codeine, morphine, methadone, oxycodone
- 7 Benzodiazepines, for example Valium, diazepam, temazepam
- 8 Hallucinogens, for example LSD, mushrooms, ketamine
- 9 Cocaine
- 10 Heroin
- 77 Other [SPECIFY]: _____

GO TO 8.12

95 NOT ON SHOWCARD: None of these
.K Don't know
.R Refused

GO TO 9.01

8.12 Have you ever tried to get help to stop taking drugs, whether informally from a friend, or more formally, from a health professional? [Code one only]

- 1 Yes
- 5 No
- .K Don't know
- .R Refused

GO TO 9.01

8.13 Have you done this in the past 12 months? [Code one only]

- 1 Yes
- 5 No
- .K Don't know
- .R Refused

9. HEALTH CONDITIONS

9.01 Over the past 12 months, would you say that in general your health has been...
[Read out and code one only]

- 1 Excellent
- 2 Very good
- 3 Good
- 4 Fair
- 5 Poor

DO NOT READ OUT: .K Don't know .R Refused

9.02 Many people experience major problems, hardships or traumas in their life or upbringing. Thinking of your personal background, would you strongly agree, agree, disagree or strongly disagree that you are someone who has had a lot of trauma, hardship and problems in their life or upbringing.
[Code one only]

- 1 Strongly agree
- 2 Agree
- 3 Disagree
- 4 Strongly disagree

DO NOT READ OUT: .K Don't know .R Refused

[Showcard 9A]

9.03 Looking at Card 9A, which of the following health conditions do you currently have?
[Read out and code or record all mentioned]

95 is a unique code

- 1 Heart conditions, high blood pressure or high cholesterol
- 2 Diabetes
- 3 Cancer
- 4 Lung conditions including asthma
- 5 Depression
- 6 Anxiety disorders
- 7 Obesity
- 77 Any other physical or mental health conditions **[Specify]:** _____
- 95 None

NOT ON SHOWCARD: .K Don't know .R Refused

9.04 Do you have a disability that affected your day to day life over the past 12 months? [Code one only]
ⓘ IF ASKED: This refers to current disabilities.

- 1 Yes
- 5 No
- .K Don't know
- .R Refused

10. CONNECTEDNESS

The next questions look at how you feel about the community you live in.

10.01 Can you get help from family, friends or neighbours when you need it? [Read out and code one only]

- 1 Yes, definitely
- 3 Sometimes
- 5 No, not at all

DO NOT READ OUT: .K Don't know .R Refused

10.02 Are you a member of an organised group such as a sports or church group or another community group including those over the internet? [Code one only]

- 1 Yes
- 5 No
- .K Don't know
- .R Refused

10.03 Do you like living in your community? [Read out and code one only]

- 1 Yes, definitely
- 3 Sometimes
- 5 No – not at all
- 7 No feeling about it

DO NOT READ OUT: .K Don't know .R Refused

10.04 How would you rate the overall quality of services, facilities and 'things to do' in your community? [Read out and code one only]

- 1 Very poor
- 2 Poor
- 3 Ok
- 4 Good
- 5 Very good

DO NOT READ OUT: .K Don't know .R Refused

NEW ZEALAND DEPRIVATION INDEX (NZDI)

The following few questions are designed to identify people who have had special financial needs in the last 12 months. Although these questions may not apply directly to you, for completeness we need to ask them of everyone.

10.05 In the last 12 months have you personally been forced to buy cheaper food so that you could pay for other things you needed? [Code one only]

- 1 Yes
- 5 No
- .K Don't know
- .R Refused

10.06 In the last 12 months, have you been out of paid work at any time for more than one month? [Code one only]

Ⓢ THIS UNEMPLOYMENT QUESTION IS DEFINED AS 'NO' - 5 FOR THOSE 60 OR OVER (EG, RETIRED), FOR FULL-TIME CAREGIVERS/HOME-MAKERS OR HIGH SCHOOL/UNIVERSITY STUDENTS

- 1 Yes
- 5 No
- .K Don't know
- .R Refused

10.07 In the last 12 months, did you yourself get income from any of the following sources: Domestic Purposes Benefit, Emergency Maintenance Allowance, Sickness/Invalid's Benefit, Orphans and Unsupported Child Benefit, or the Widow's Benefit? [Code one only]

Ⓢ SELECT YES 1 ONLY IF RESPONDENT RECEIVES ONE OR MORE OF THESE BENEFITS

- 1 Yes
- 5 No
- .K Don't know
- .R Refused

10.08 In the last 12 months, have you personally put up with feeling cold to save heating costs? [Code one only]

- 1 Yes
- 5 No
- .K Don't know
- .R Refused

10.09 In the last 12 months, have you personally made use of special food grants or food banks because you did not have enough money for food? [Code one only]

- 1 Yes
- 5 No
- .K Don't know
- .R Refused

10.10 In the last 12 months, have you personally continued wearing shoes with holes because you could not afford replacement? [Code one only]

- 1 Yes
- 5 No
- .K Don't know
- .R Refused

10.11 In the last 12 months have you personally gone without fresh fruit and vegetables, often, so that you could pay for other things you needed? [Code one only]

- 1 Yes
- 5 No
- .K Don't know
- .R Refused

10.12 In the last 12 months, have you personally received help in the form of clothes or money from a community organisation (like the Salvation Army)? [Code one only]

- 1 Yes
- 5 No
- .K Don't know
- .R Refused

11. DEMOGRAPHICS

This is the last section. The purpose of this section is to collect some general information about you and your household. We need to ask these questions again as some of the details may have changed.

11.01 Code gender [Code one]

- 1 Male
- 8 Female

11.02 a. Can you please tell me your date of birth? [Record] ① Enter eight digit date (eg, 4 March 1946 = 04031946).

	→	GO TO 11.02b
.R Refused	→	GO TO 11.03

b. The computer has calculated that you are 'XX' [calculate age] years old. Is that correct? [Code one only]

1 Yes	→	GO TO 11.05
5 No	→	GO TO 11.02a, AND ASK FOR CORRECT DATE OF BIRTH
.R Refused	→	GO TO 11.05

① Ask only if refused date of birth question (i.e. code .R selected in 11.02a)

11.03 Would you mind telling me what age you turned on your last birthday? [Record]

① Enter age

	→	GO TO 11.05
.K Don't know	} →	GO TO 11.04
.R Refused to give exact age		

① Ask only if refused in 11.02a, and don't know or refused in 11.03.

[Showcard 11A]

11.04 From Card 11A, can you tell me which of these age groups you belong to? [Code one]

- 1 18-19 years
- 2 20-24 years
- 3 25-29 years
- 4 30-34 years
- 5 35-39 years
- 6 40-44 years
- 7 45-49 years
- 8 50-54 years
- 9 55-59 years
- 10 60-64 years
- 11 65-69 years
- 12 70-74 years
- 13 75 or over years
- .R Refused

[Showcard 11B]

11.05 Looking at Card 11B, which ethnic group or groups do you belong to? [Code all mentioned]
Ⓢ IF RESPONDENT ANSWERS WITH NATIONALITY RATHER THAN ETHNICITY, PROBE FURTHER AND RECORD ETHNICITY

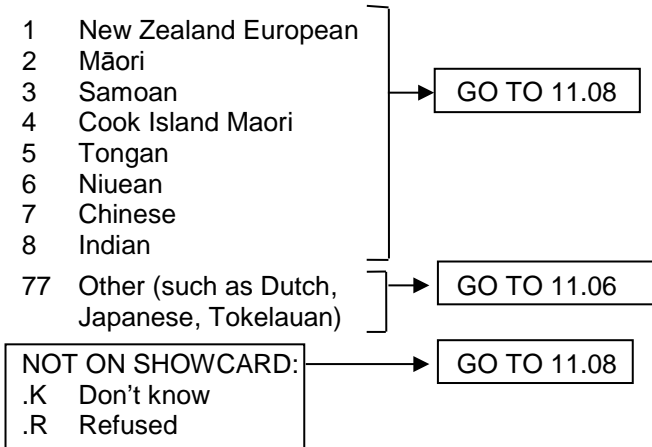

11.06 What other ethnicity or ethnicities do you belong to? [Code all that apply]

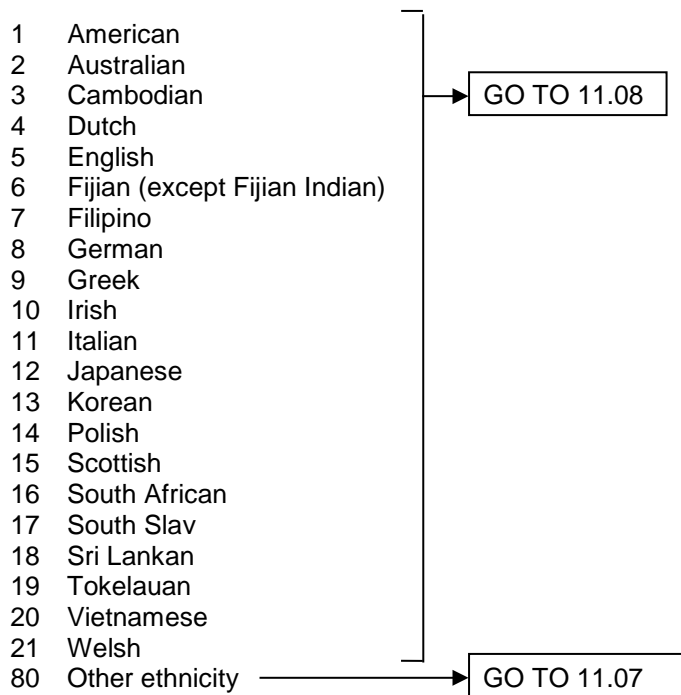

11.07 Please specify your other ethnic group or groups. [Record]

-
- .K Don't know
 - .R Refused

[Showcard 11C]

11.08 Now looking at Card 11C, which is your first language? [Code one only]

- 1 English
- 2 Maori
- 3 Samoan
- 4 NZ sign language
- 77 Other language, eg, Gujarati, Cantonese, Greek **[Specify]:** _____
- .K Don't know
- .R Refused

[Showcard 11D]

11.09 Please refer to Card 11D and tell me what is your ability to speak te reo Maori? [Code one only]

- 1 Strong
- 2 Adequate
- 3 Limited
- 4 None
- .K Don't know
- .R Refused

CULTURAL IDENTITY QUESTIONS

The following questions are about your culture.

① If code ① only selected in 11.05 go to 11.16

[Showcard 11D]

11.10 Looking at Card 11D, what is your sense of cultural identity? [Code one only]

- 1 Strong
- 2 Adequate
- 3 Limited
- 4 None
- .K Don't know
- .R Refused

If 11.08 = 1, skip to 11.12.

[Showcard 11E]

11.11 Now looking at Card 11E, what opportunities do you have to speak <INSERT LANGUAGE SELECTED IN 11.08> with others who speak your language? [Code one only]

- 1 Plenty
- 2 Adequate
- 3 Limited
- 4 None
- .K Don't know
- .R Refused

[Showcard 11F]

11.12 What is the level of access you have to cultural activities and gatherings? Please refer to Card 11F. [Code one only]

- 1 High
- 2 Adequate
- 3 Limited
- 4 None
- .K Don't know
- .R Refused

[Showcard 11D]

11.13 Please look at Card 11D and tell me what is your ability to access culturally-based or relevant support? [Code one only]

- 1 Strong
- 2 Adequate
- 3 Limited
- 4 None
- .K Don't know
- .R Refused

11.14 a. Which country were you born in? [Code one only]

- 1 New Zealand → GO TO 11.16a
- 2 Australia
- 3 China (People's Republic of)
- 4 Cook Islands → GO TO 11.15
- 5 England
- 6 Fiji
- 7 Hong Kong
- 8 India
- 9 Korea
- 10 Malaysia
- 11 Netherlands
- 12 Philippines
- 13 Samoa
- 14 Scotland
- 15 Singapore
- 16 South Africa
- 17 Taiwan
- 18 Tonga
- 19 United States
- 77 Other → GO TO 11.14b
- .K Don't know } GO TO 11.15
- .R Refused }

b. What is that 'other country'? [Record]:

-
- .K Don't know
 - .R Refused

11.15 In what year did you arrive to live in New Zealand? [Record]

① Record 4 digit date eg, 1967.

① Answer should be ≥ year of birth.

--	--	--	--

- .K Don't know
- .R Refused

[Showcard 11G]

11.16 a. Looking at Card 11G, in which languages could you have a conversation about a lot of everyday things? [Code or record all mentioned]

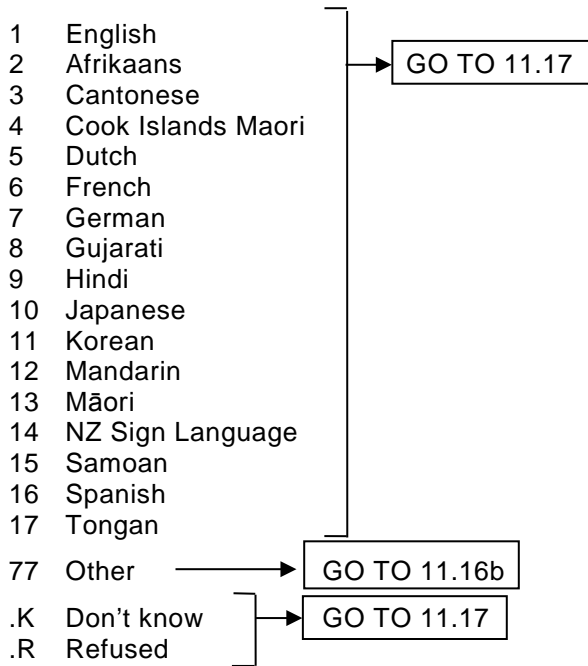

b. What is that 'other language'? [Record]:

.K Don't know
.R Refused

[Showcard 11H]

11.17 Looking at Card 11H, which best describes you at the moment? [Code one only]
① IF NECESSARY: 'Employment is considered full-time when an employee works an average of 30 hours or more each week, in any or all of their jobs, this includes Self-Employed.'
'Working in paid employment includes students if they have any paid employment.'

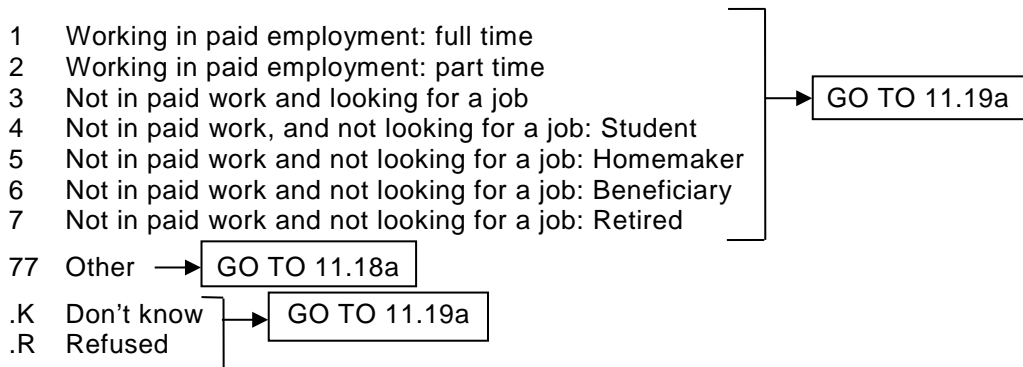

11.18 a. Can you describe that please? [Record]

.K Don't know
.R Refused

b. And is that [Read out and code one only]

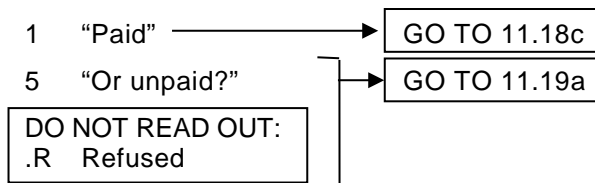

c. And is that paid work [Read out and code one only]

- 1 "Full time"
- 5 "Or part time?"

DO NOT READ OUT:
.R Refused

[Showcard 11I]

11.19 a. Looking at Card 11I, can you please tell me your highest secondary school qualification?

[Circle one]

① UE / University Entrance – check which year obtained re. answer option 3 or 5

- 1 No formal school qualification/None
- 2 NZ School Certificate in one or more subjects or National Certificate Level 1 or NCEA Level 1
- 3 NZ Sixth Form Certificate in one or more subjects or National Certificate Level 2 or NZ UE before 1986 in one or more subjects or NCEA Level 2
- 4 NZ Higher School Certificate or Higher Leaving Certificate
- 5 University Entrance 1986 onwards
- 6 Bursary/Scholarship or National Certificate Level 3
- 7 NCEA Level 3 or NZ Scholarship Level 4

GO TO 11.20a

8 Other secondary school qualification gained in NZ → GO TO 11.19b

9 Other secondary school qualification gained overseas → GO TO 11.20a

NOT ON SHOWCARD:
.K Don't know
.R Refused

b. What is that 'other NZ secondary school qualification'? [Record]:

-
- .K Don't know
 - .R Refused

[Showcard 11J]

11.20 a. Apart from secondary school qualifications, do you have another completed qualification? Please do not count incomplete qualifications or qualifications that take less than 3 months of full-time study to get. Using Card 11J, please tell me your highest qualification. [Circle one]

- 1 No qualification beyond secondary school
- 2 Bachelors degree, for example, BA, BSc
- 3 Bachelors degree with honours
- 4 Masters degree, for example, MA, MSc
- 5 PhD
- 6 Diploma (*not* post-graduate)
- 7 Diploma – post-graduate
- 8 Trade or technical certificate which took more than 3 months full-time study
- 9 Professional qualification, for example, ACA, teachers, nurses

GO TO 11.21a

77 Other → GO TO 11.20b

NOT ON SHOWCARD → GO TO 11.21a

.K Don't know
.R Refused

b. What is that 'other qualification'? [Record]:

-
- .K Don't know
 - .R Refused

[Showcard 11K]

11.21 a. Looking at Card 11K, and thinking about the people in your household, who do you usually live with? [Code all mentioned]

① IF NEEDED: 'We are interested in people in different living situations'

Programmer: 1 is a unique code.

1 Live alone → GO TO 11.25

2 Partner / husband / wife

3 Mother

4 Father

5 Grandparents

6 Brother / sister

7 Aunt / Uncle

8 Own children (including step children, foster, whangai)

9 Grandson / granddaughter

10 Niece / nephew

11 Cousins

12 Others' children (eg belong to someone else in household)

13 Other family

14 Friends

15 Flatmates

77 Other → GO TO 11.21b

NOT ON SHOWCARD → GO TO 11.22

.K Don't know

.R Refused



b. Who is that 'other person'? [Record]:

.K Don't know

.R Refused

[Showcard 11L]

11.22 Looking at Card 11L, and including yourself, can you tell me the age groups of the people who usually live in this house? [Code each age group]

Ⓛ IF NEEDED: 'USUALLY means the person lives in the house for four or more days per week'.

11.23 a. And how many people are there in your household, in each age group you mentioned? [Record number for each group coded in 11.23]

Programmer:

1. Display only those age groups coded in 11.22.
2. Allow a maximum of 17 groups.
3. Allow one digit per age group in 11.23.
4. Calculate 'TOTAL' to insert into 11.24.

11.22	Age Groups of Household Members	11.23	Number of People in Each Age Group
1	0-4 years		
2	5-9 years		
3	10-14 years		
4	15-17 years		
5	18-19 years		
6	20-24 years		
7	25-29 years		
8	30-34 years		
9	35-39 years		
10	40-44 years		
11	45-49 years		
12	50-54 years		
13	55-59 years		
14	60-64 years		
15	65-69 years		
16	70-74 years		
17	75 or over years		
.K	Don't know	→	GO TO 11.25
.R	Refused		

b. Programmer: Record total

TOTAL =

11.24 a. So, including yourself, there are [TOTAL IN 11.23] people usually living in this house? [Code one only]

- 1 Yes
- 5 No → GO TO 11.22 AND 11.23, AND CORRECT NUMBERS WITH RESPONDENT
- .K Don't know → GO TO 11.25
- .R Refused

b. Programmer: Record total for 11.23 codes 5-17

[Showcard 11M]

11.25 What is the total income that you personally got from all sources, before tax or anything was taken out of it, in the last 12 months? Please call out the number on the right of Card 11M, that comes closest to the group your personal income comes into. [Code one only]

- 1 Less than \$5,000
- 2 \$5,001 - \$10,000
- 3 \$10,001 - \$15,000
- 4 \$15,001 - \$20,000
- 5 \$20,001 - \$25,000
- 6 \$25,001 - \$30,000
- 7 \$30,001 - \$35,000
- 8 \$35,001 - \$40,000
- 9 \$40,001 - \$50,000
- 10 \$50,001 - \$60,000
- 11 \$60,001 - \$70,000
- 12 \$70,001 - \$80,000
- 13 \$80,001 - \$90,000
- 14 \$90,001 - \$100,000
- 15 \$100,001 - \$120,000
- 16 \$120,001 - \$150,000
- 17 \$150,001 or more

NOT ON SHOWCARD:
 .K Don't know
 .R Refused

Programmer:
 If 1 (live alone) is selected in 11.21a, and any of 1 to 17 selected in 11.25, go to 11.28.
 If 1 (live alone) is selected in 11.21a, and .K or .R selected in 11.25, go to 11.27.
 Otherwise, go to 11.26.
 If .K, .R selected in 11.25 and 1-18 selected in 11.26 go to 11.28.

[Showcard 11N]

11.26 What is the total income that your household got from all sources, before tax or anything was taken out of it, in the last 12 months? Please call out the number on the right of Card 11N, that comes closest to the group your household comes into. [Code one only]

- 1 Less than \$5,000
- 2 \$5,001 - \$10,000
- 3 \$10,001 - \$15,000
- 4 \$15,001 - \$20,000
- 5 \$20,001 - \$25,000
- 6 \$25,001 - \$30,000
- 7 \$30,001 - \$35,000
- 8 \$35,001 - \$40,000
- 9 \$40,001 - \$50,000
- 10 \$50,001 - \$60,000
- 11 \$60,001 - \$70,000
- 12 \$70,001 - \$80,000
- 13 \$80,001 - \$90,000
- 14 \$90,001 - \$100,000
- 15 \$100,001 - \$120,000
- 16 \$120,001 - \$150,000
- 17 \$150,001 - \$200,000
- 18 \$200,001 or more

NOT ON SHOWCARD:
 .K Don't know
 .R Refused

GO TO 11.28

GO TO 11.27

[Showcard 11O]

11.27 Looking at Card 11O, would you be able to confirm if your total household annual income is roughly in one of these groups? [Code one only]

- 1 Less than \$20,000
- 2 \$20,001 - \$40,000
- 3 \$40,001 - \$60,000
- 4 \$60,001 - \$80,000
- 5 \$80,001 - \$100,000
- 6 \$100,001 - \$120,000
- 7 \$120,001 - \$150,000
- 8 More than \$150,000

NOT ON SHOWCARD:

- .K Don't know
- .R Refused

[Showcard 11P]

11.28 Looking at Card 11P, can you please tell me what your religion is? [Code all mentioned]

Code 1 is a unique code

- 1 No religion → GO TO THANKS SCREEN
- 2 Christian → GO TO 11.29
- 3 Buddhist → GO TO 11.31
- 4 Hindu → GO TO 11.31
- 5 Muslim → GO TO 11.31
- 6 Jewish → GO TO 11.31
- 77 Other religion → GO TO 11.30

NOT ON SHOWCARD

- .K Don't know
- .R Refused

GO TO THANKS SCREEN

[Showcard 11Q]

11.29 Looking at Card 11Q, can you please tell me which of these, if any, you are? [Code all mentioned]

- 1 Anglican → GO TO 11.31
- 2 Catholic → GO TO 11.31
- 3 Presbyterian → GO TO 11.31
- 4 Methodist → GO TO 11.31
- 5 Ratana → GO TO 11.31
- 6 Ringatu → GO TO 11.31
- 77 Other → GO TO 11.30

NOT ON SHOWCARD

- .K Don't know
- .R Refused

GO TO 11.31

11.30 Can you please tell me your other religion and/or denomination? [Record]:

-
- .K Don't know
 - .R Refused

11.31 How often do you participate in organised religious activities? [Read out and code one]:

- 1 Once a week or more often
- 2 Two or three times a month
- 3 Monthly
- 4 Once or twice a year
- 5 Less often than once a year
- 95 Never
- 77 Other (PLEASE SPECIFY): _____
- .K Don't know
- .R Refused

[THANKS] Thank you very much for answering these questions. Your answers will be very helpful in this study. There are just a few more questions and then we have finished. Any information you give me from now on will not be stored with your answers for the survey.

12. CLOSING INFO

RECONTACT

12.01 Could I please get your landline phone number? This is just so my Supervisor can call you to check my work, or to check you are happy with the way the interview was conducted. [Code one only]
Again we need to ask these questions in case there have been any changes.

- 1 Yes
 - 3 Don't have one
 - 5 No
 - .K Don't know
- } → GO TO 12.03

12.02 Could I have that landline number including the area code please? [Record 9 digits]:
ⓐ ENTER LANDLINE PHONE NUMBER: 00 000 0000, INCLUDING AREA CODE.
ⓑ IF PREFIX 021, 025 OR 027 IS GIVEN, CHECK FOR A LANDLINE NUMBER.

--	--	--	--	--	--	--	--	--	--

12.03 Would it be alright if I get your cell phone number? Sometimes it's easier to reach people this way. [Code one only]

- 1 Yes
 - 3 Don't have one
 - 5 No
 - .K Don't know
- } → GO TO 12.05

12.04 Could I have that cell phone number, including the prefix please? [Record between 9 (minimum) and 11 (maximum) digits]:

--	--	--	--	--	--	--	--	--	--	--

12.05 Do you have an email address, in case we cannot contact you by phone? [Code one only]

- 1 Yes
- 5 No → GO TO 12.07

12.06 Could I have that email address? [Record email address]: _____

- .K Don't know
- .R Refused

12.07 Would you be happy to be contacted within the next 2 years about the possibility of answering further questions on behalf of the AUT/MoH?
Saying yes to this question won't commit you, it just means they can contact you to ask if you would like to participate again. [Code one only]

- 1 Yes, you can contact me and ask if I want to help again
- 5 No, don't contact me again → GO TO THANK YOU

12.08 Can I record your name? [Code one only]

- 1 Yes
- 5 No →

12.09 ① IF NECESSARY: 'What title shall I put?' [Record]: _____

12.10 What is your first name? [Record]: _____

12.11 What is your surname or last name? [Record]: _____

12.12 a. Can I have your address please? [Code one only]

- 1 Yes [Write address below]
- 5 No →

b. What is your address? [Record]: _____
① IF NECESSARY: Eg: 12 Sycamore St or 47b Smith Rd.

12.13 And the suburb (or rural delivery)? [Record]: _____

12.14 And the town or city (or region)? [Record]: _____

12.15 And lastly the postcode? [Record 4 digit postcode]:

12.16 Just in case you move house within the next two years, could you please give us the name of a family member or friend who would know your new contact details?

- 1 Yes [Write name below]

- 5 No →

12.17 What is their best contact phone number? [Record]

12.18 And if they have one, could you give me their email address? [Code one only]

- 1 Yes [Record email address]: _____
- 3 No, don't have one
- 5 No

12.19 And just in case we are unable to contact them, could you give us the name of another person who would know your new contact details?

- 1 Yes [Write name below]

- 5 No →

12.20 What is their best contact phone number? [Record]

12.21 And if they have one, could you give me their email address? [Code one only]

- 1 Yes **[Record email address]:** _____
- 3 No, don't have one
- 5 No

[THANKS AGAIN]

That's all the questions I have to ask you.

On behalf of the AUT/Ministry of Health, thank you once again for talking with me.

[Give Thank You card]

I would like to reassure you that your answers remain confidential. As I said, my name is XXXX and I'm from National Research Bureau.

INTERVIEWER OBSERVATION:

What level of language assistance, if any, was used for the interview? [Code one only]

- 1 None
- 2 The interviewer helped interpret questions into a language other than English
- 3 A friend/family member helped interpret into a language other than English
- 4 Official interpreter was used
- .K Don't know

[End survey]